



深圳市弗瑞鑫电子有限公司

规格承认书

—

prepare	
check	
approve	



TRX电容一级代理商
深圳市弗瑞鑫电子有限公司

深圳市宝安区西乡大道302号金源商务大厦B座301

0755-29563634

0755-27447020



/ . .			



/ . .

! /

!

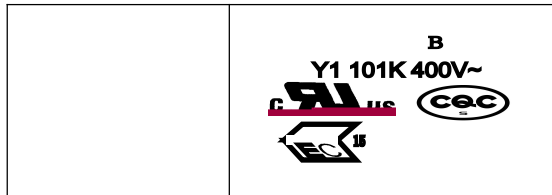

	/ . .			



.

.

.





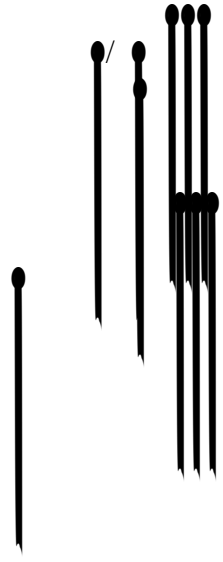

.

. .

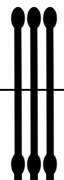
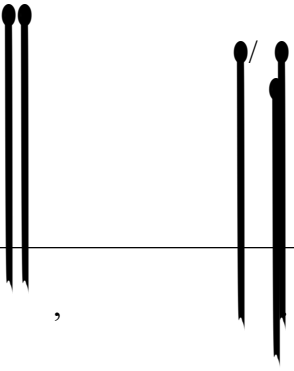
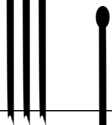
-

-

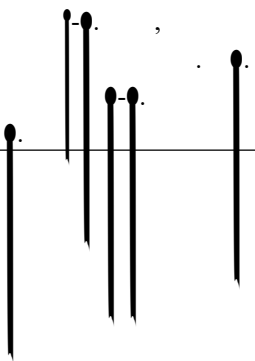

	..					
	.					
	.			..		
				%		
				%		
				%		
				%		
						
					<p>()</p> 	

					+
					-
				%	
				%	
()					
				(-)/ %	



TRX 特锐祥

专 注 电 容 器 11 年





•

• • • •

• • • •

/ . .			

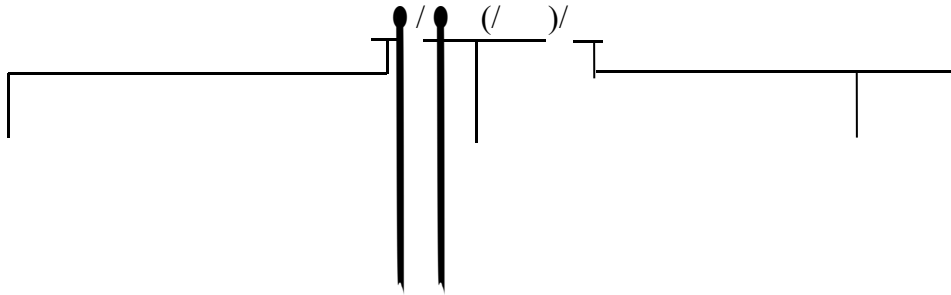

(/) /
(/)
(/)

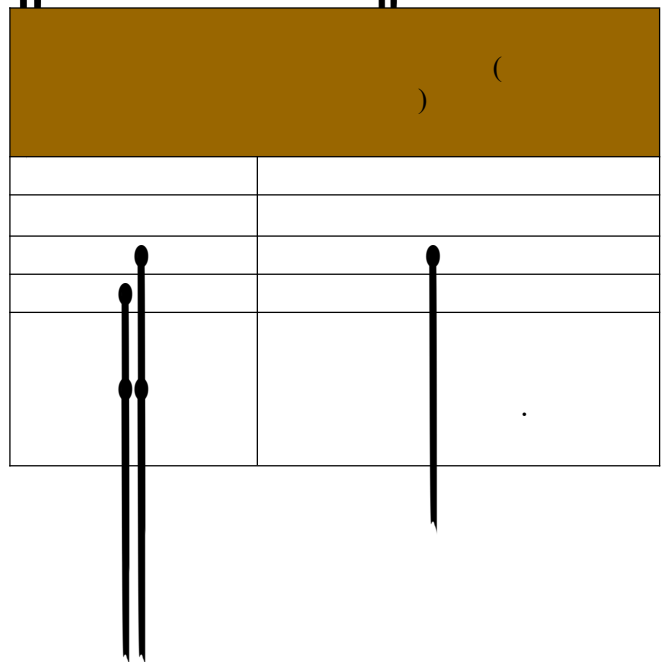
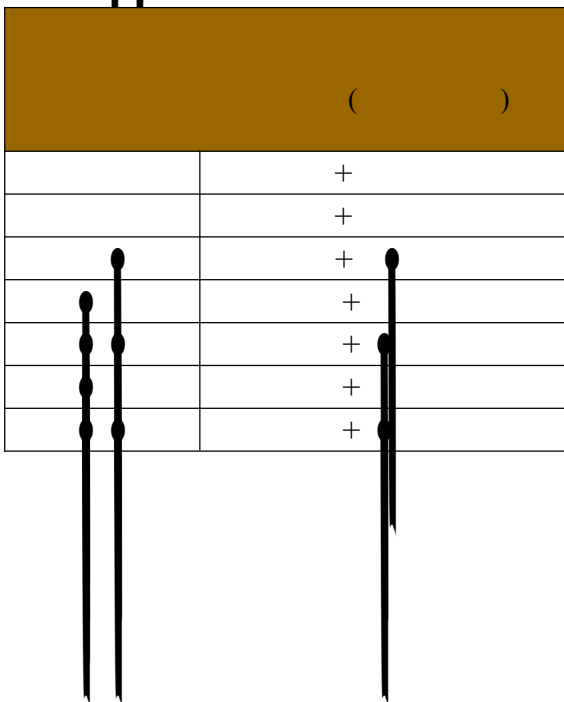
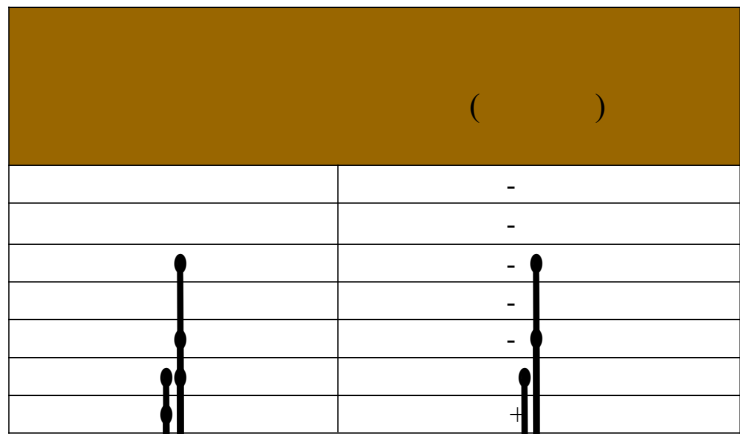
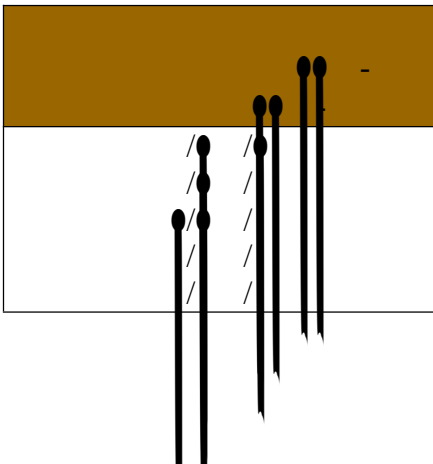

/ ..

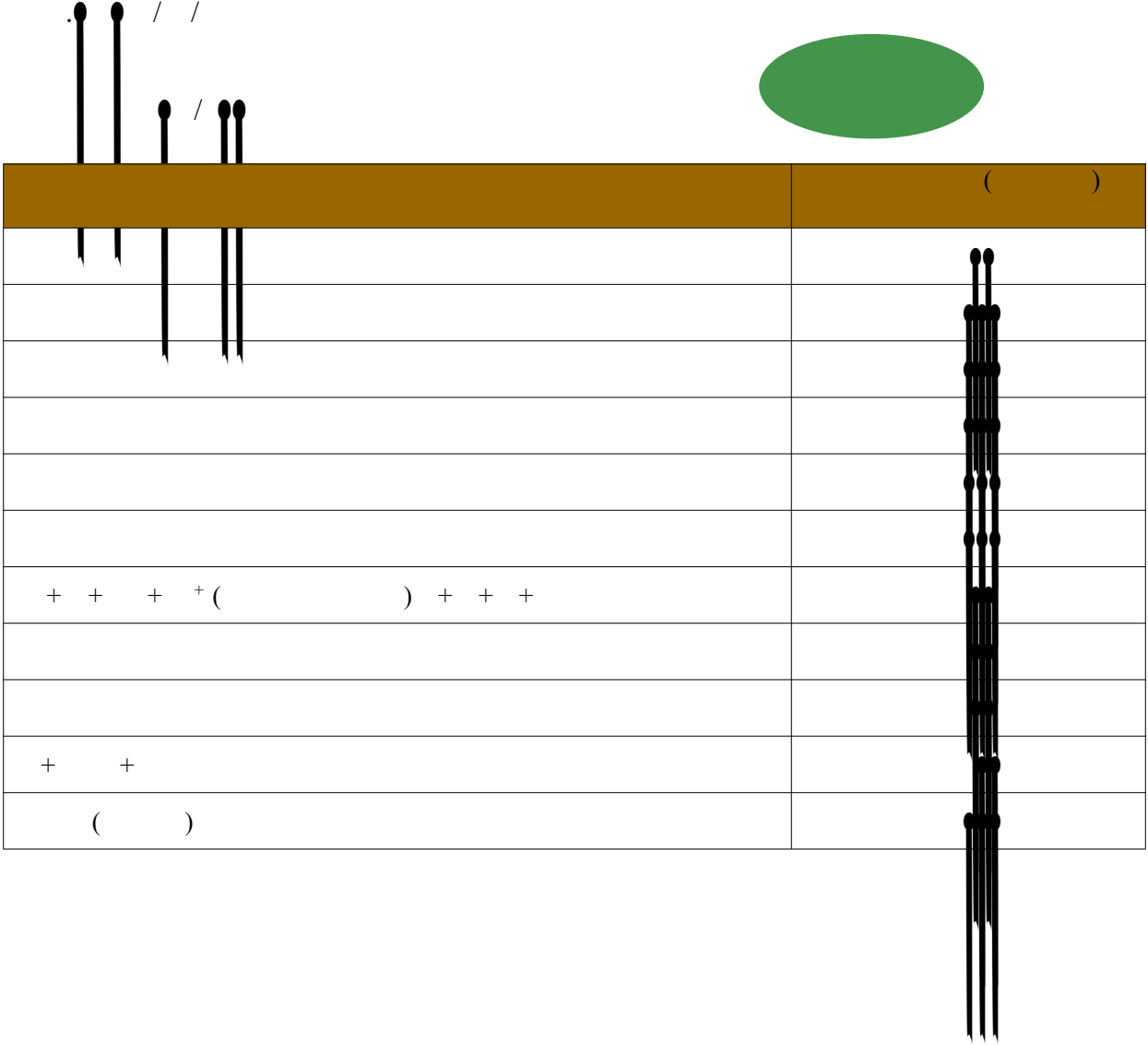

+ + + + () + + +

+ +

()

	(/ . .			



/ . .			

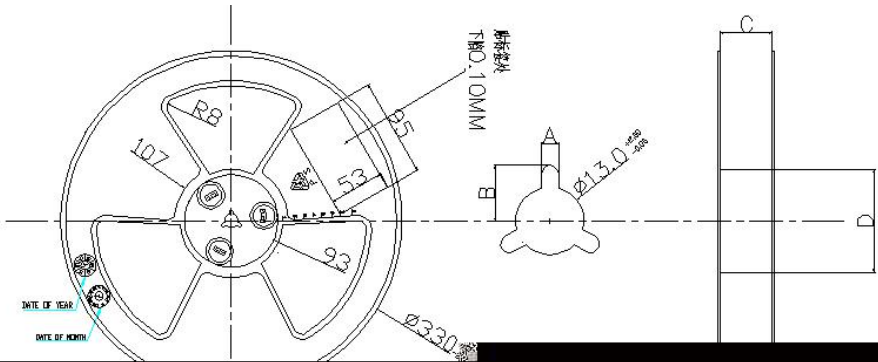
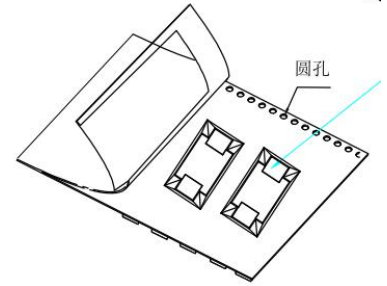
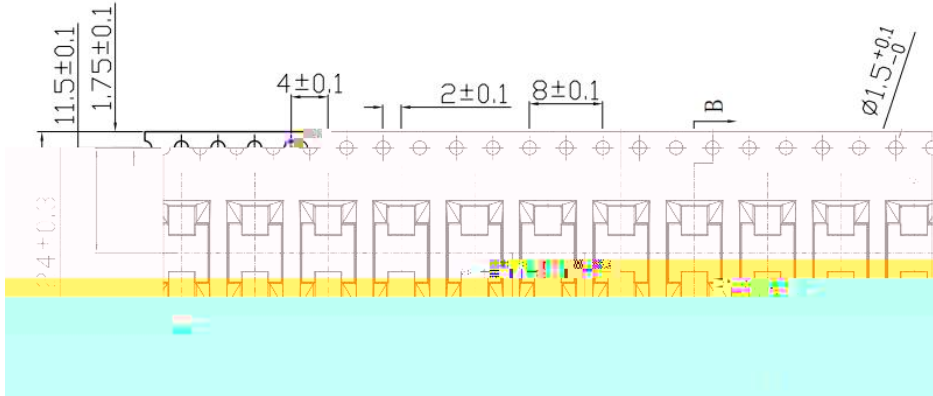

Item	Data	Remark
Cover tape adhesion	10 ~ 100g	Carrier tape and cover tape open angle 165 ~ 180° F=300±5mm/minute

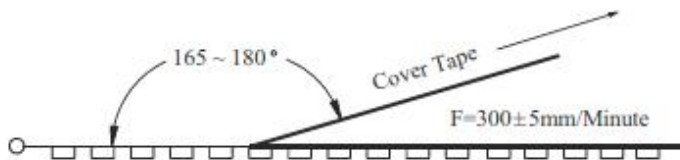

/ . .			

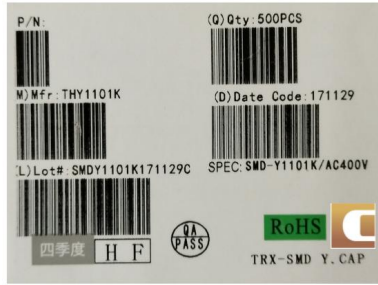

	/
	#

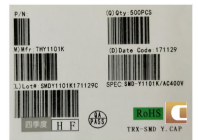
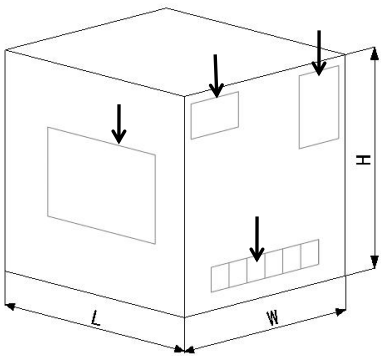

()			

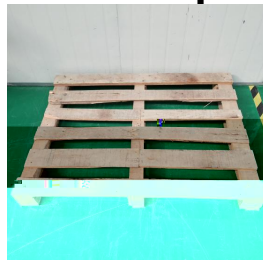

/

(/ /)

(/ /)

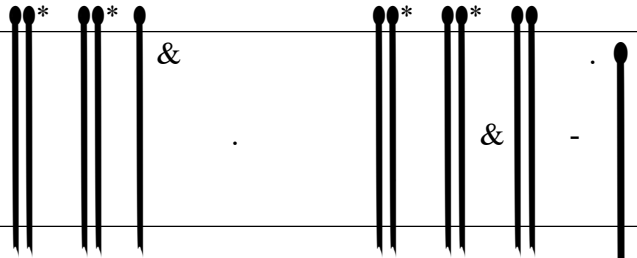

	/ . .			

..

-

.

..

..

.....

.

.

....

..

,

.

	/ . .			

()

,

.

.

.

,

.



TRX 特锐祥

专 注 电 容 器 11 年

/ . .			

