



---

---

---

---

---





J  
F 3225 K 471 G2

FRX®

4032

贴片尺寸:  
SMD Size:  
3225≈8.2×6.3mm  
4032≈11.0×8.2mm

15寸料盘卷装:  
15" Reel packing:  
3225: 1820PCS/reel  
4032: 1500PCS/reel

压敏电压公差: ±10%  
Varistor voltage

压敏电压 (V1mA):  $47 \times 10^1 = 470V$

Varistor voltage tolerance: ±10%

Varistor voltage (V1mA):  $47 \times 10^1 = 470V$

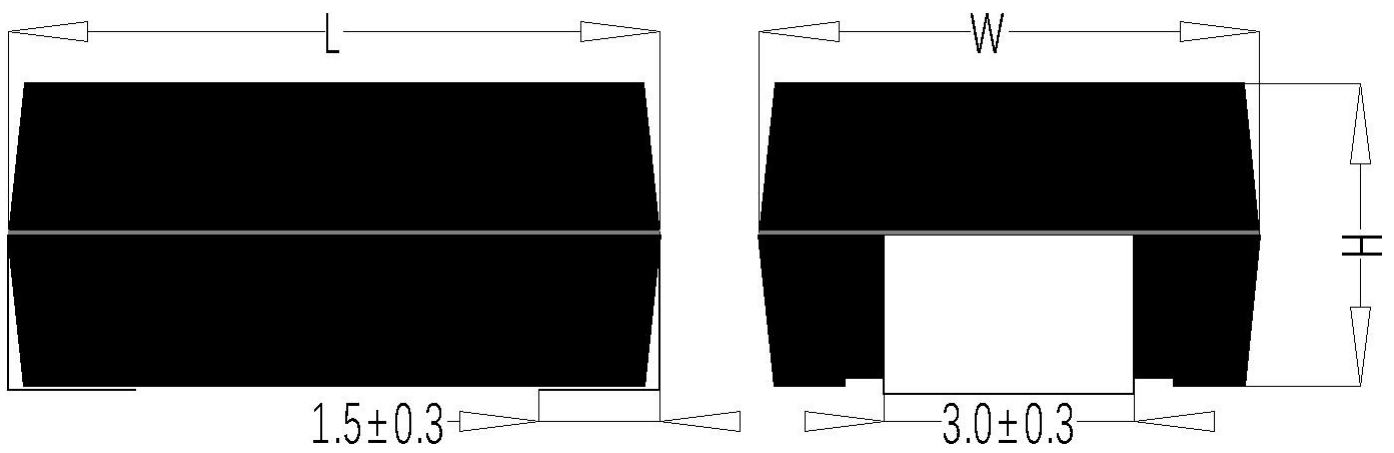









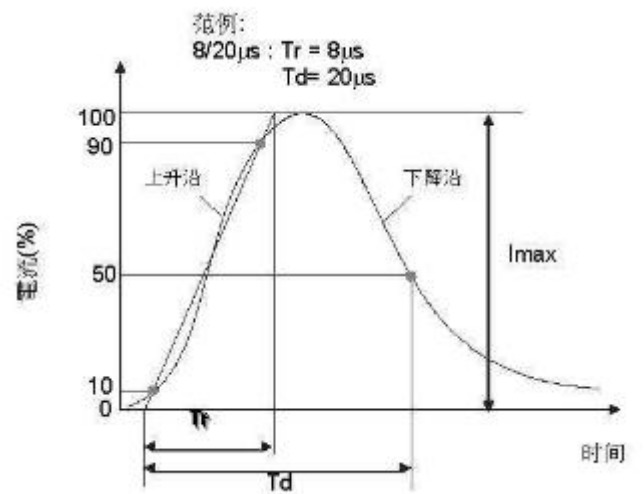
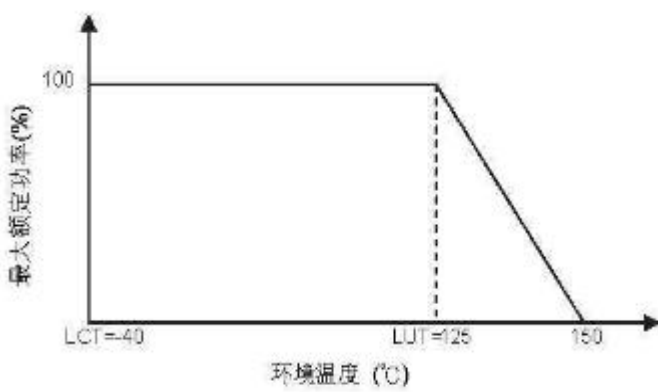



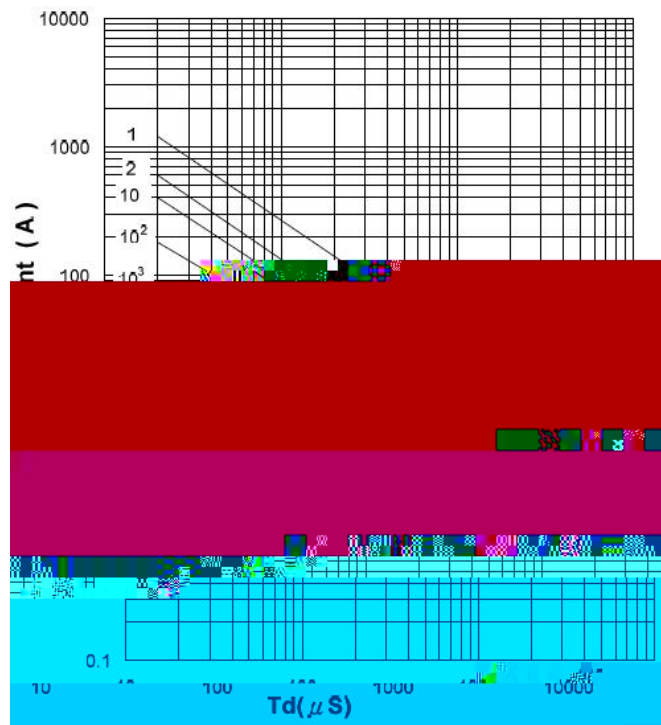
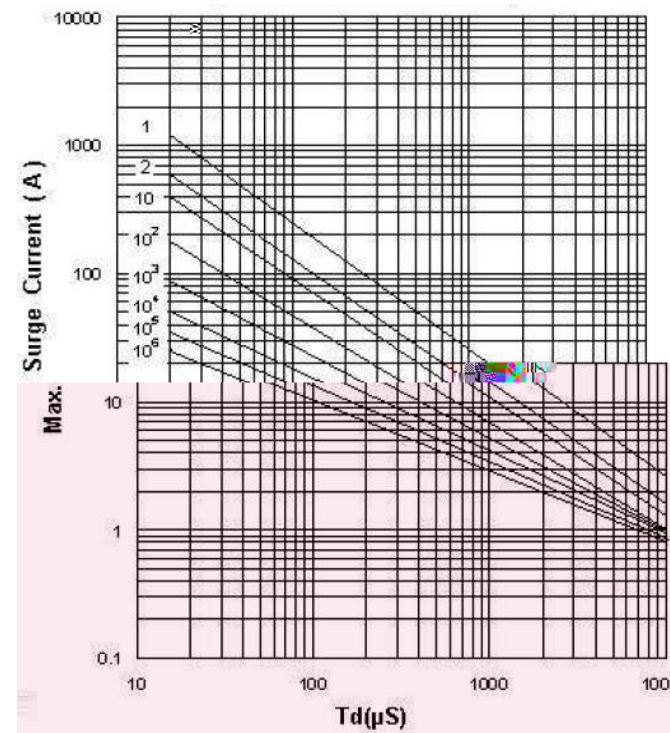
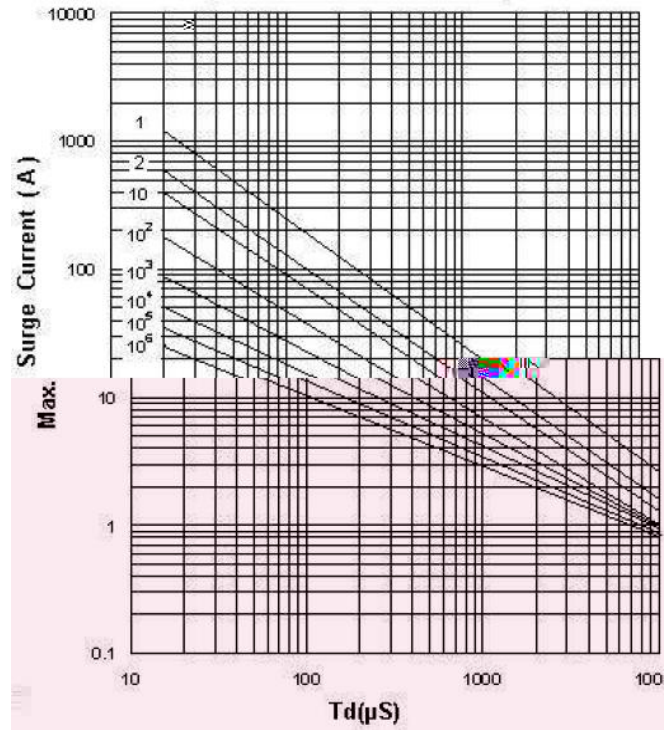
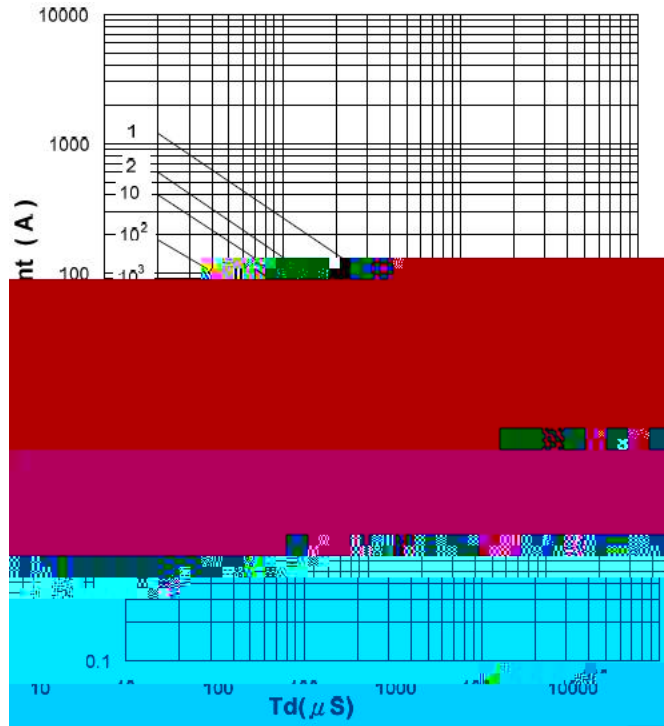



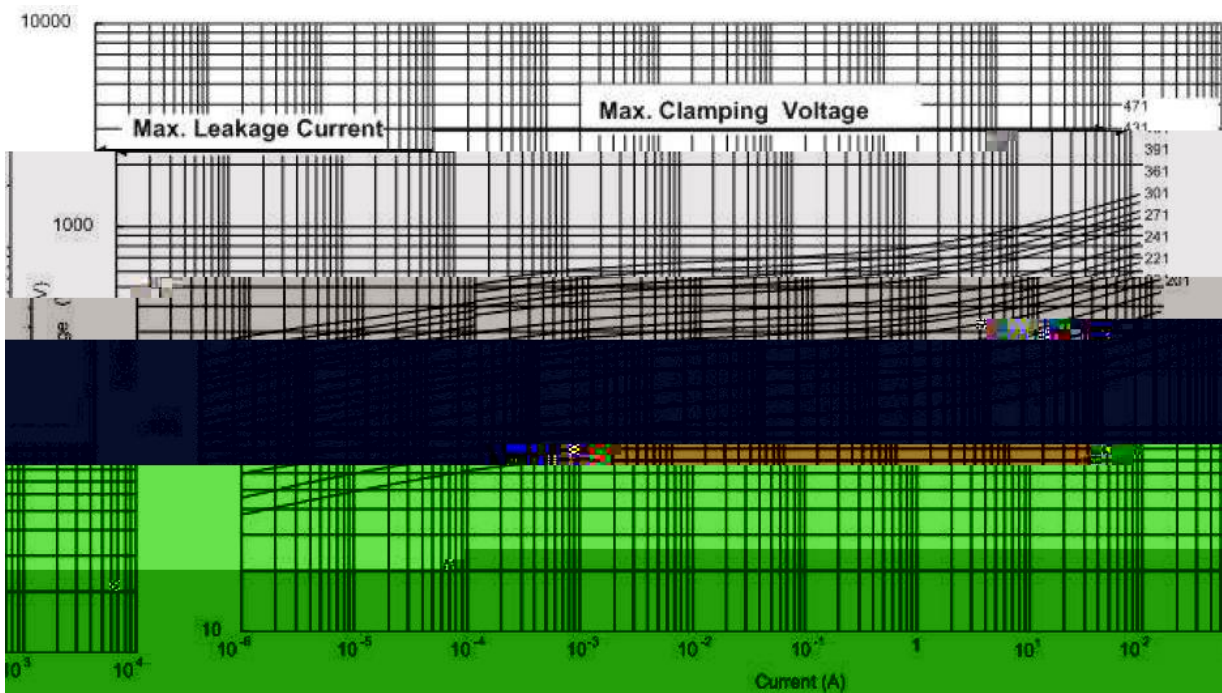
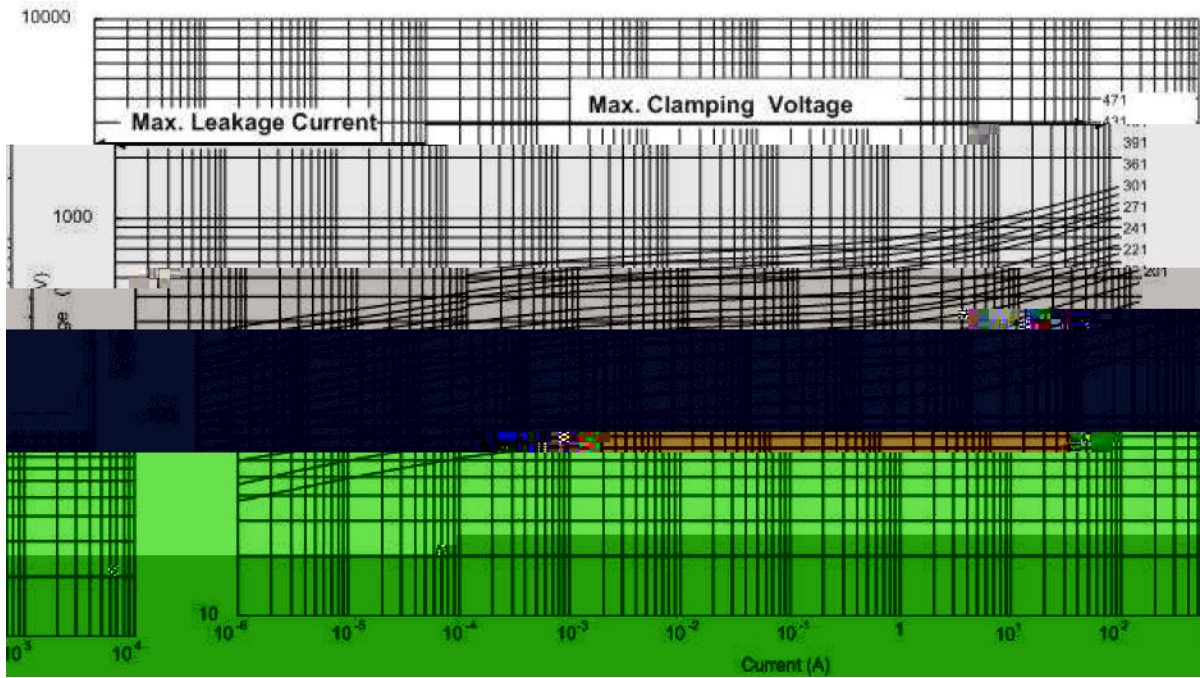

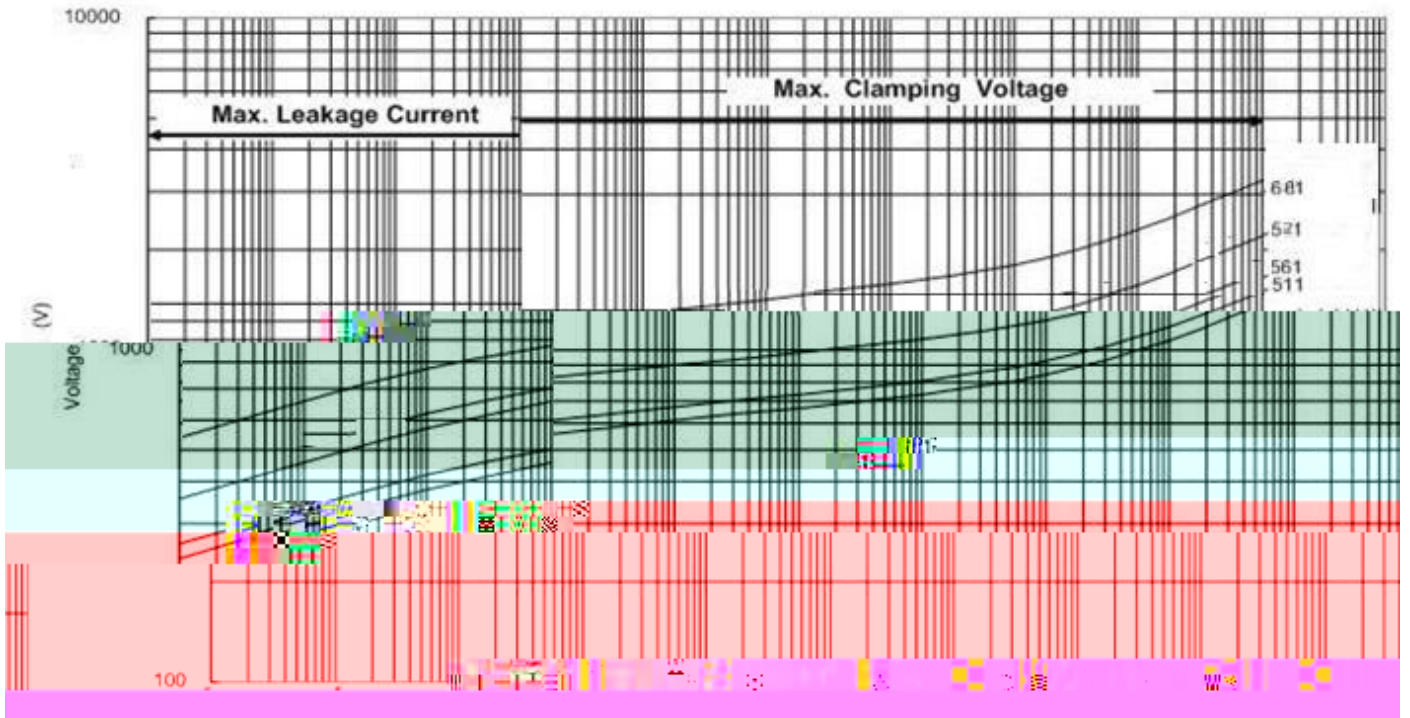

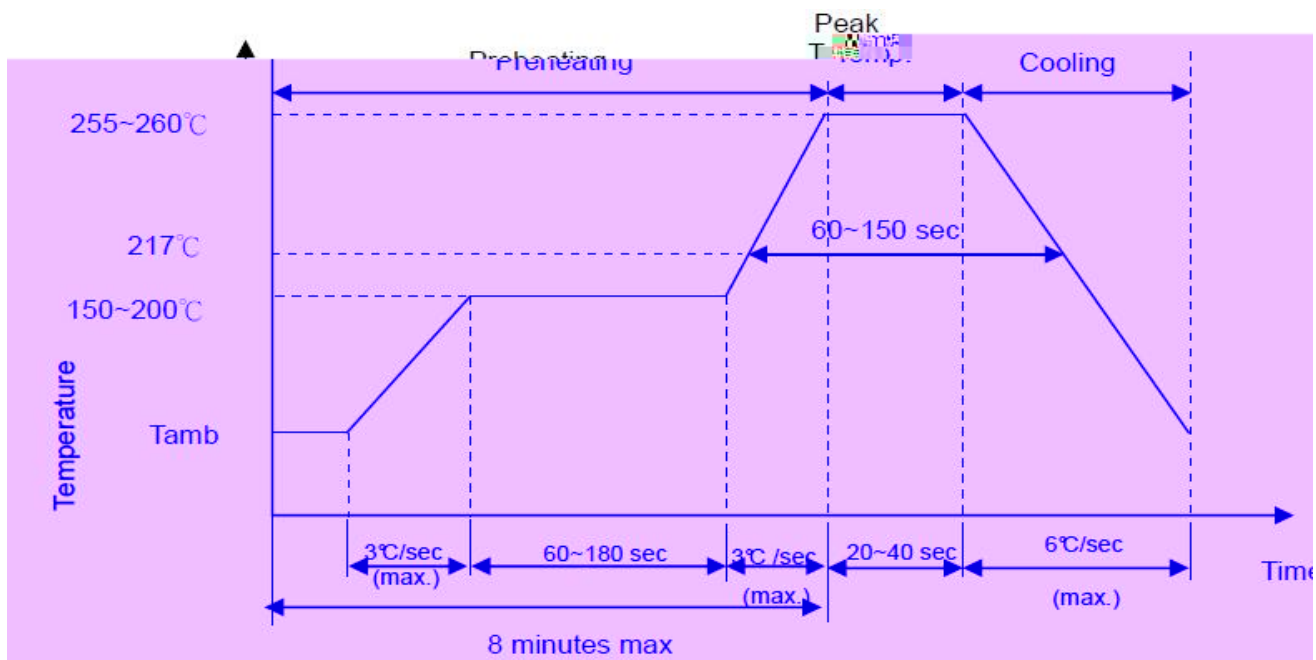
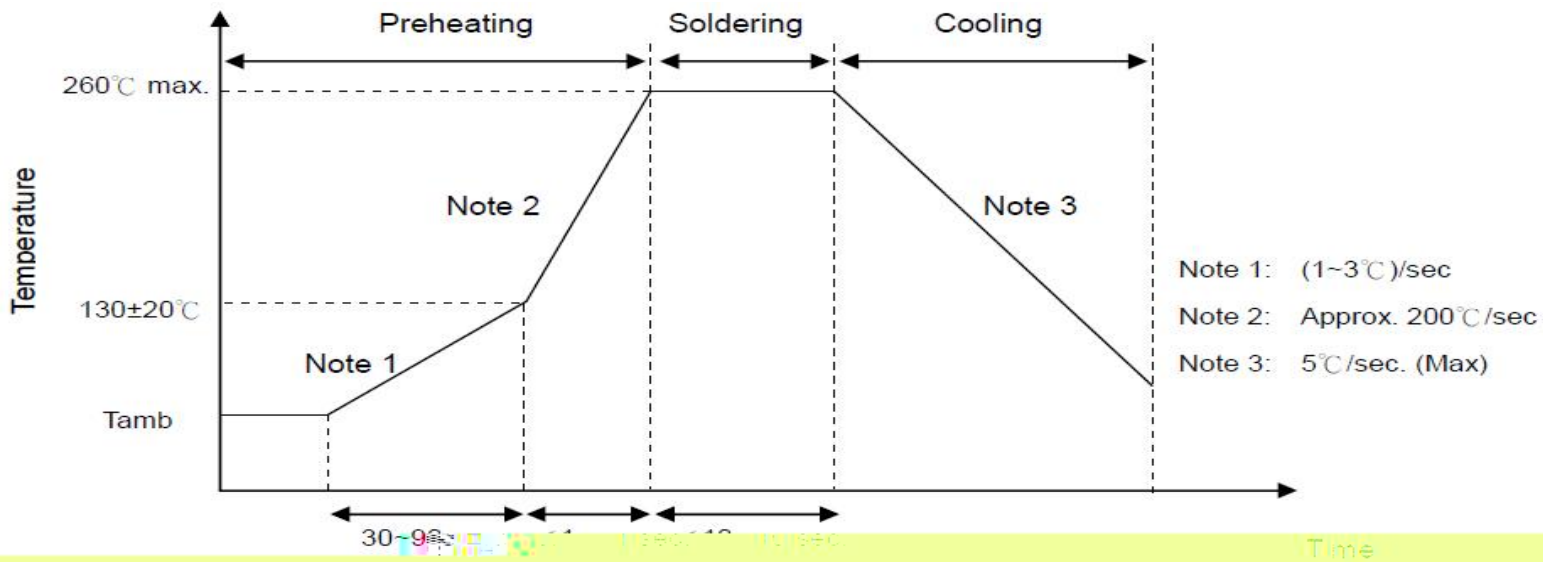





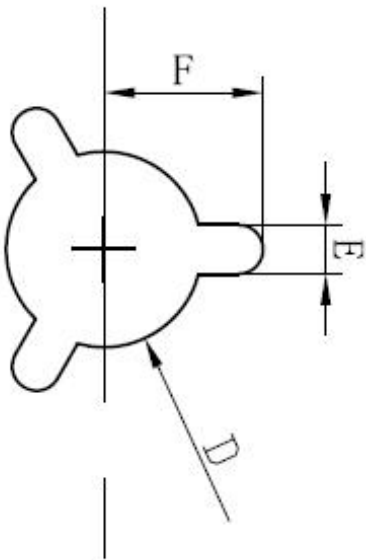
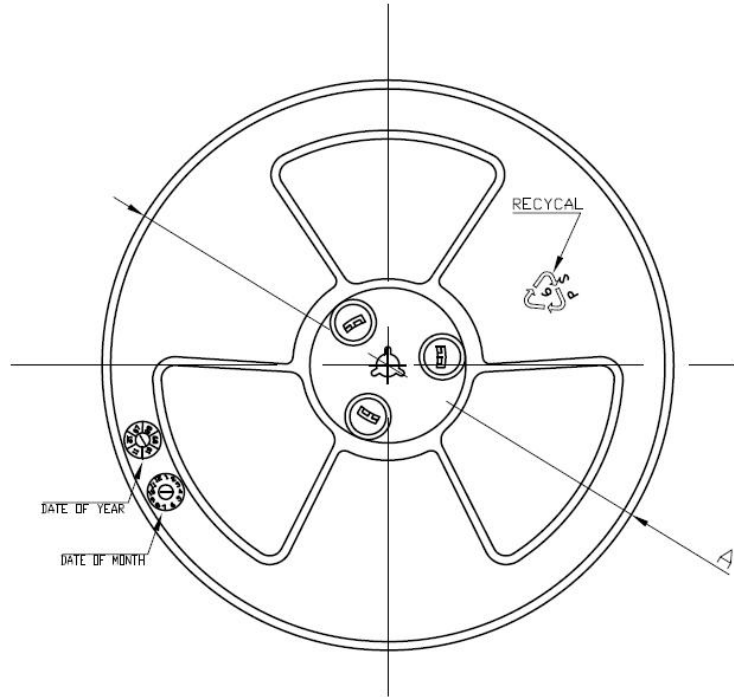

(



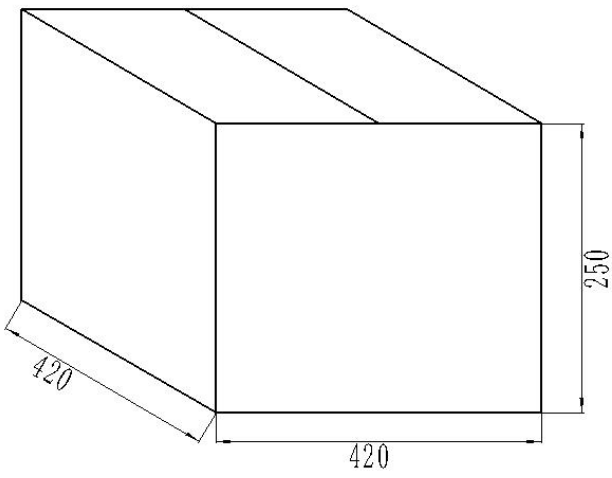

(



1820pcs × 11盘/Reel  
←  
20000pcs

