

规格承认书

*

—

			*

prepare	* *			
check				
approve				* * *



TRX电容一级代理商

深圳市弗瑞鑫电子有限公司

Add: 深圳市宝安区西乡大道302号金源商务大厦B座3楼

Tel: 0755-29563634

Fax: 0755-27447020

- 2

2 . .

/

/

/

/

	- 2 2 . .		
	/		/
	/		/

1. /

① ② ③ ④ ⑤ ⑥

①					
②					
③					
④					
⑤					
⑥					

2. /



	- 2 2 . .		
	/		/
	/		/

3. /



4. /

5. /





①		
②		
③		
④		
⑤		

- 2
2 ..

/

/

/

/

	- 2 2 . .		
	/		/
	/		/

/

°
°C

°

°

°

/

7. /

	- 2 2 . .		
	/		/
	/		/



L~~17~~



- 2
2 ..

/

/

/

/

					±
		±			
		±			
		±			
		±			

			± ±
			± ±
			± ±
			± ±

8. /

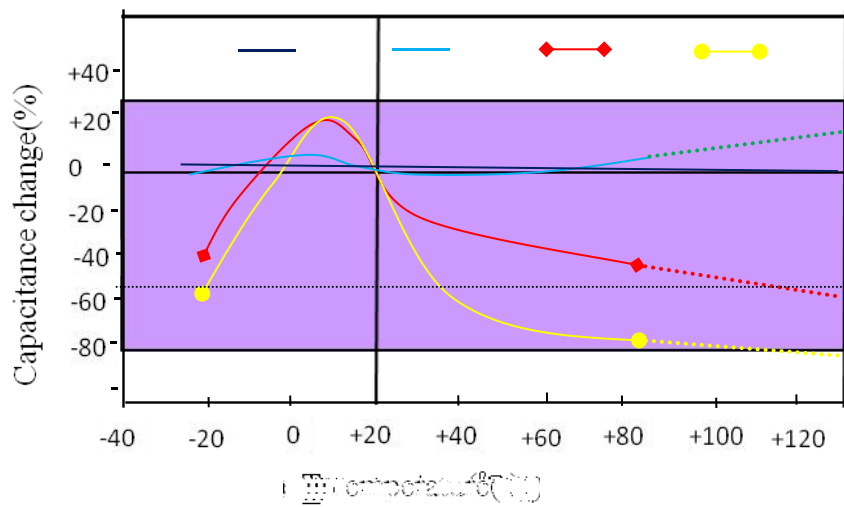

 TRX 专注电容器廿年	- 2 2 ..		
	/		/
	/		/

9. /



10. /
(1)

(2)

/
/

(3)

(4)

x

11. /
/

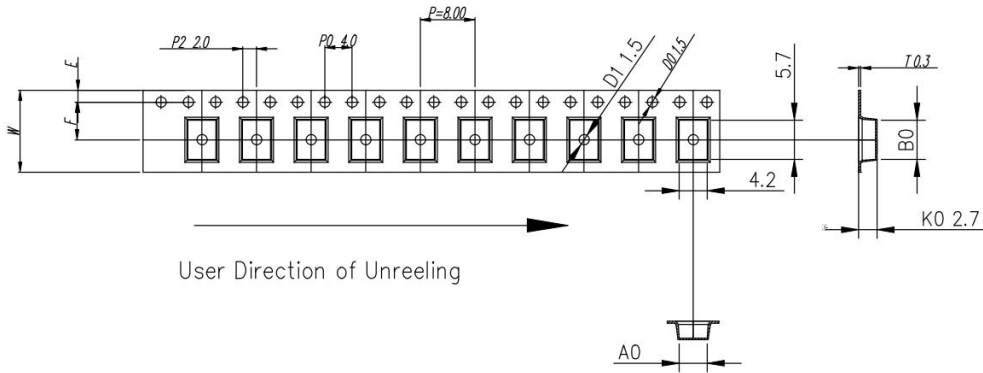

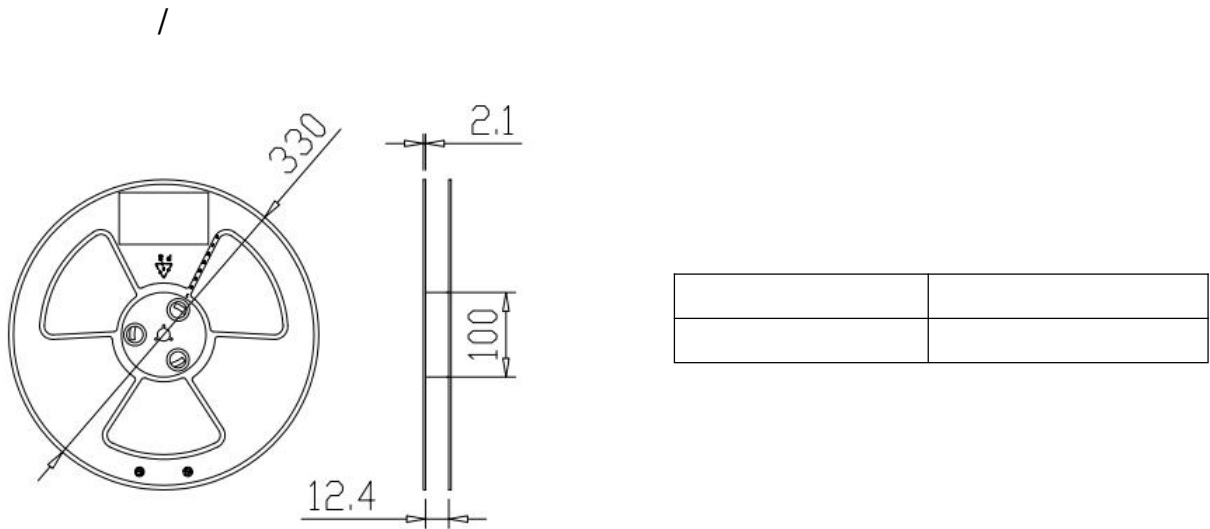

ITEM	W	A0	B0	K1	K0	P	F	E	D0	D1	P0	P2	T
DIM	12.0	$4.38^{+0.30}_{-0.30}$	$5.70^{+0.10}_{-0.10}$	--	$2.70^{+0.10}_{-0.10}$	8.00	$5.50^{+0.10}_{-0.10}$	1.75	$1.5^{+0.10}_{-0.10}$	$1.5^{+0.10}_{-0.10}$	4.0	2.0	$0.30^{+0.05}_{-0.05}$
ALTERNATE													

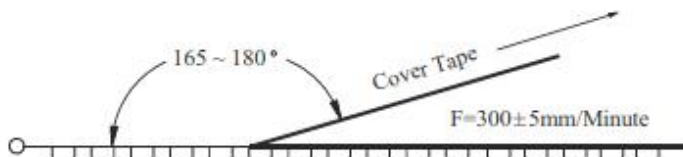

/

Item	Data	Remark
Cover tape adhesion	10 ~ 100g	Carrier tape and cover tape open angle 165 ~ 180° F=300±5mm/minute

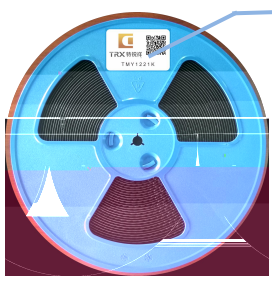

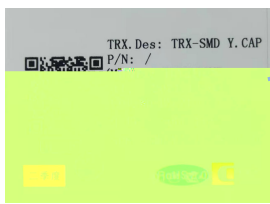
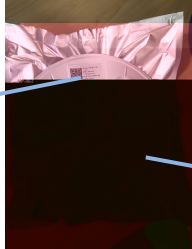
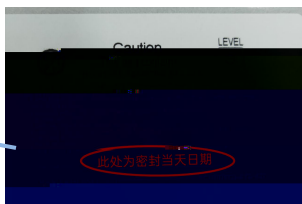
/ -			
 <p>标签</p>	 <p>料号</p>		
		 <p>此处为密封当天日期</p>	

/ -			
	 <p>图示 /</p>	 <p>图示 /</p>	 <p>图示 /</p>

/ :			
			
/	/		

" "

	- 2 2 . .		
	/		/
	/		/

12. /

①

②