

TRX 特锐祥
专 注 电 容 器 廿 年



SMD- 1
SMD 1 . .

/N

/D

/E

/P

/

I

/

II

TR SMD- 1.CAP
C R T.C D

(U : F

T.C						

	SMD- 1 SMD 1 . .		
	/N		/D
	/E		/P





SMA

0 1 ..

/D

/P

 TRX 专注电容器廿年	SMD- 1 SMD 1 . .		
	/N		/D
	/E		/P

/E	
	
	± ±
	
	
	
	

3. /D

↓	↓				
		↓	↓		

 TRX 专注电容器廿年	SMD- 1		
	SMD 1 . .		
	/N		/D
/E		/P	

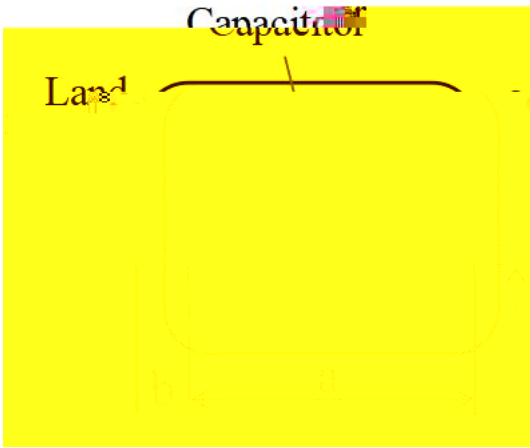

6. /S
/

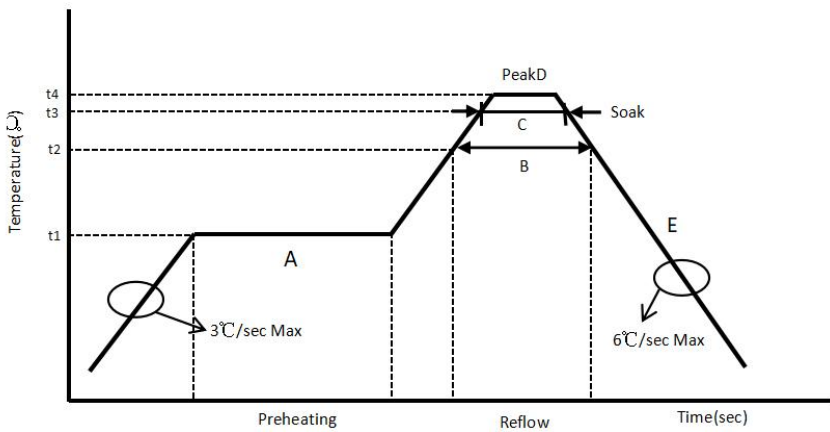

	SMD- 1 SMD 1 . .		
	/N		/D
	/E		/P

/

/

7. /P

SMD- 1
SMD 1 . .

/N

/D

/E

/P



						<table border="1"><tr><td></td><td></td><td></td><td></td><td></td><td></td></tr><tr><td></td><td></td><td></td><td></td><td></td><td></td></tr></table>													
						±													



SMD- 1
SMD 1 . .

/N

/D

/E

/P

 TRX 专注电容器廿年	SMD- 1 SMD 1 . .		
	/N		/D
	/E		/P

			± ±
			± ± ±
			± ± ±
			± ± ±

8. /C

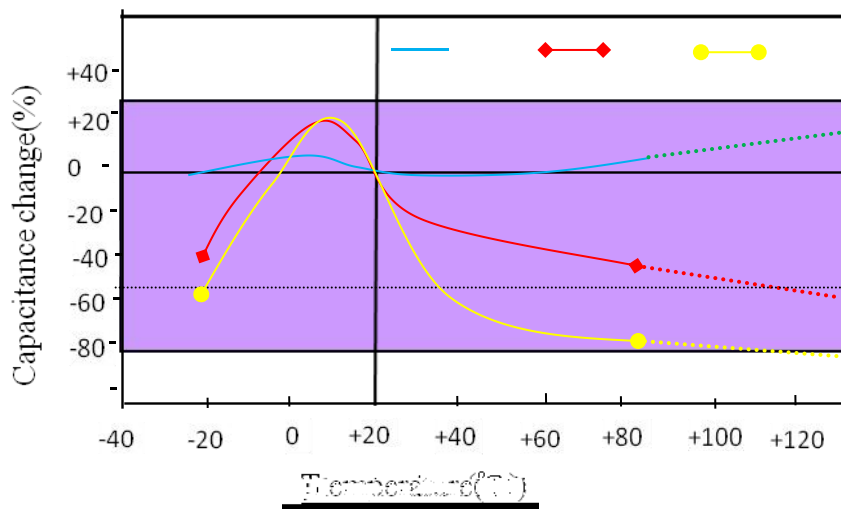

	SMD- 1		
	SMD 1 . .		
	/N		/D
	/E		/P

9.

/C

**R HS H.F.
REACH**

10.

/S

/

/

×

11. /P
/

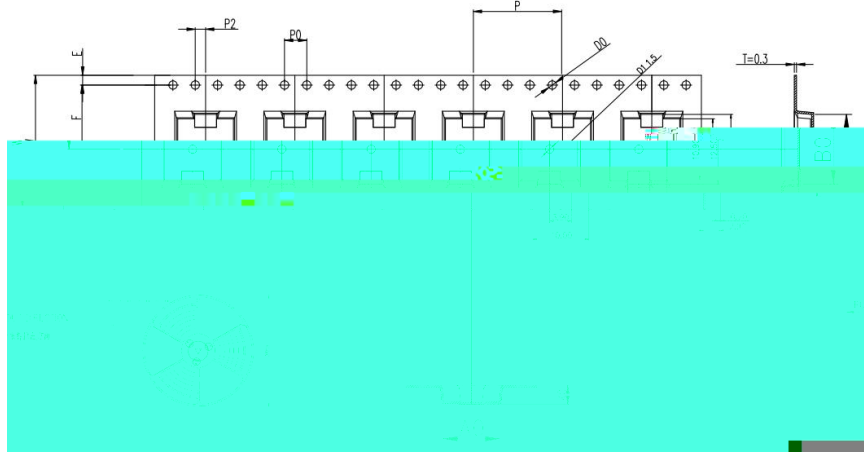

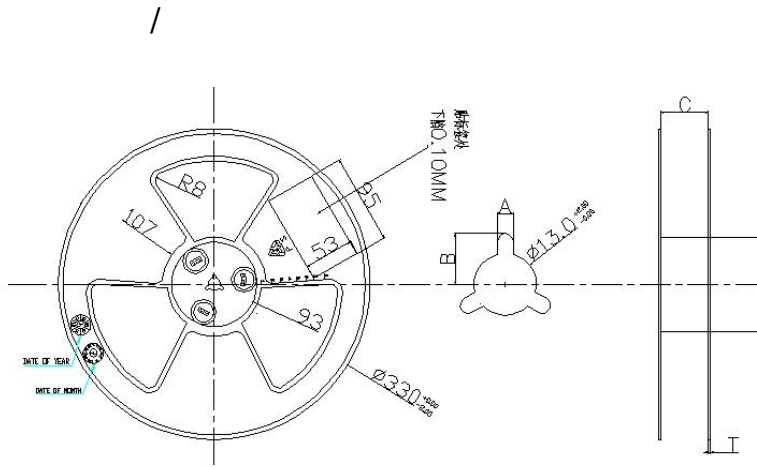

ITEM	W	A0	B0	K1	K0	P	F	E	D0	D1	P0	P2	T										
DIM	24.0	$^{+0.30}_{-0.30}$	$^{+0.10}_{-0.10}$	$^{+0.10}_{-0.10}$	$^{+0.10}_{-0.10}$	3.45	$^{+0.10}_{-0.10}$	16.0	$^{+0.10}_{-0.10}$	11.50	$^{+0.10}_{-0.10}$	1.75	$^{+0.10}_{-0.10}$	$\varnothing 1.5$	$^{+0.10}_{-0.00}$	$\varnothing 1.5$	$^{+0.10}_{-0.00}$	4.0	$^{+0.10}_{-0.10}$	2.0	$^{+0.10}_{-0.10}$	0.30	$^{+0.05}_{-0.05}$





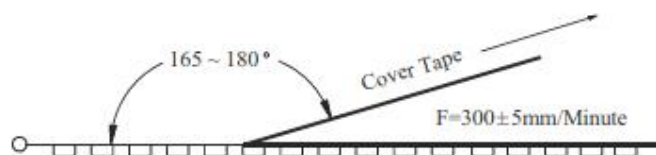



SPEC	A±0.3	B±0.5	C $^{+0.5}_{-0.0}$	D±0.5	T±0.2
24	2.3	10.75	24.4	Ø97	2.2

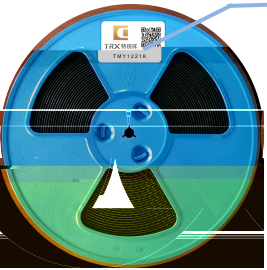

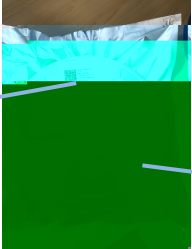
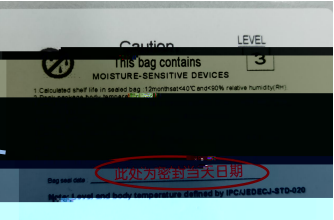
Item	Data	Remark
Cover tape adhesion	10 ~ 100g	Carrier tape and cover tape open angle 165 ~ 180° F=300± 5mm/minute

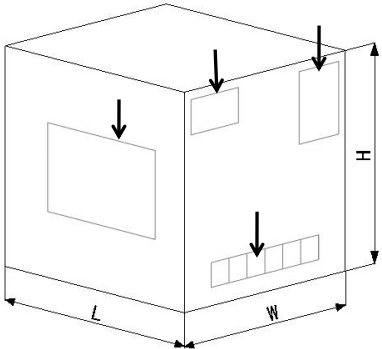

 TRX 专注电容器廿年	SMD- 1		
	SMD 1 . .		
	/N		/D
		/P	

/ -	 			
				

/O -				
		/	/	/

/P :				
	/	/		

R	" "
---	-----

