

规格承认书

—

| | | | |
|--|--|--|--|
| | | | |
| | | | |

| | |
|---------|--|
| prepare | |
| | |
| check | |
| | |
| approve | |
| | |



TRX 特锐祥
专 注 电 容 器 11 年

TRX电容一级代理商
深圳市弗瑞鑫电子有限公司

Add: 深圳市宝安区西乡大道302号金源商务大厦B座3楼

Tel: 0755-29563634

Fax: 0755-27447020

SMD- 2

SMD 2 . .

/N

/D

/E

/P

| | | | |
|---|-----------------------------------|--|----|
|  | SMD- 2 SMD 2 . . | | |
| | /N | | /D |
| | /E | | /P |

| | | | |
|---|-----------------------------------|--|----|
|  | SMD- 2 SMD 2 . . | | |
| | /N | | /D |
| | /E | | /P |

1. /P N

T B 2 102 M E
 ① ② ③ ④ ⑤ ⑥

①

| | | | |
|---|-----------------------------------|--|----|
|  | SMD- 2 SMD 2 . . | | |
| | /N | | /D |
| | /E | | /P |

3. /D



| | | | |
|---|-----------------------------------|--|----|
|  TRX 专注电容器廿年 | SMD- 2 SMD 2 . . | | |
| | /N | | /D |
| | /E | | /P |

4. /C

| | | | |
|--|--|--|--|
| | | | |
| | | | |
| | | | |
| | | | |
| | | | |
| | | | |

5. /P



| | | | |
|--|--|--|--|
| | | | |
| | | | |
| | | | |
| | | | |
| | | | |

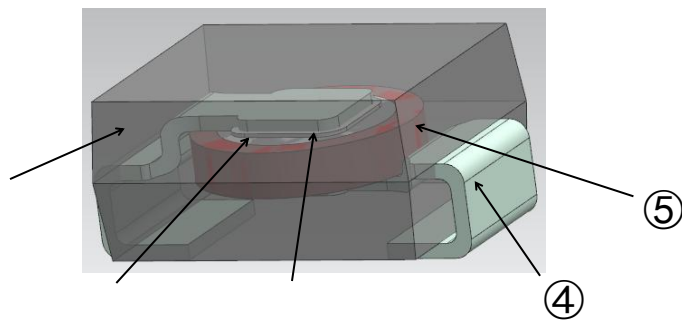

| | | |
|---|--|--|
| | | |
| ① | | |
| ② | | |
| ③ | | |
| ④ | | |
| ⑤ | | |

SMD- 2
SMD 2 . .

/N

/D

/E

| | | | |
|---|-----------------------------------|--|----|
|  TRX 专注电容器廿年 | SMD- 2 SMD 2 . . | | |
| | /N | | /D |
| | /E | | /P |

/

°
°C

°

°

°

/

7. /P

| | | | |
|--|--|--|--|
| | | | |
| | | | |
| | | | |



TRX
 专注电容器廿年

SMD- 2
 SMD 2 . .

/N

/D

/E

/P

| | | | | ± | | | | | | |
|--|--|--|--|---|--|--|--|--|--|--|
| | | | | | | | | | | |

| | | | | | |
|--|--|--|--|--|--|
| | | | | | |
| | | | | | |

△



SMD- 2
SMD 2 . .

/N

/D

/E

/P

| | | | | ± | |
|--|--|---|--|---|--|
| | | | | | |
| | | ± | | | |
| | | ± | | | |
| | | ± | | | |
| | | | | | |
| | | | | | |
| | | | | | |
| | | | | | |
| | | | | | |
| | | | | | |
| | | | | | |
| | | ± | | | |
| | | | | | |
| | | | | | |

SMD- 2
SMD

| | | | |
|---|-----------------------------------|--|----|
|  TRX 专注电容器廿年 | SMD- 2 SMD 2 . . | | |
| | /N | | /D |
| | /E | | /P |

| | | | |
|--|--|--|-----|
| | | | |
| | | | ± ± |
| | | | ± ± |
| | | | ± ± |
| | | | ± ± |
| | | | ± ± |
| | | | ± ± |
| | | | ± ± |
| | | | ± ± |
| | | | ± ± |

8. /C

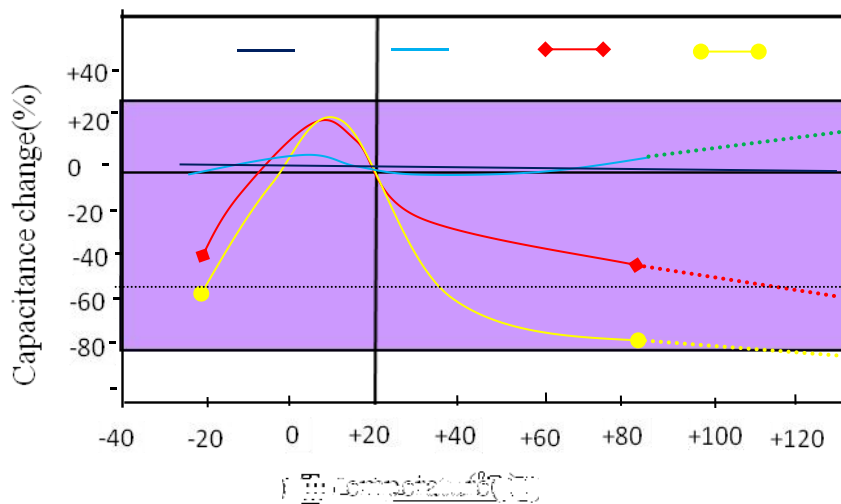

| | | | |
|---|-----------|----|----|
|  | SMD- 2 | | |
| | SMD 2 . . | | |
| | /N | | /D |
| /E | | /P | |

9. /C

R HS H.F.
REACH

10. /S

(1)

(2)

/
/

(3)

(4)

×

| | | | |
|---|------------------|--|----|
|  TRX 专注电容器廿年 | SMD- 2 | | |
| | SMD 2 . . | | |
| | /N | | /D |
| | /E | | /P |

11. /P P
/

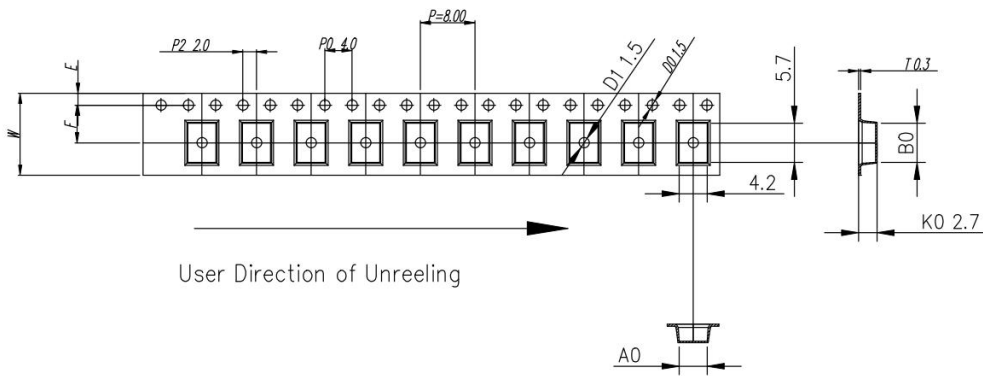

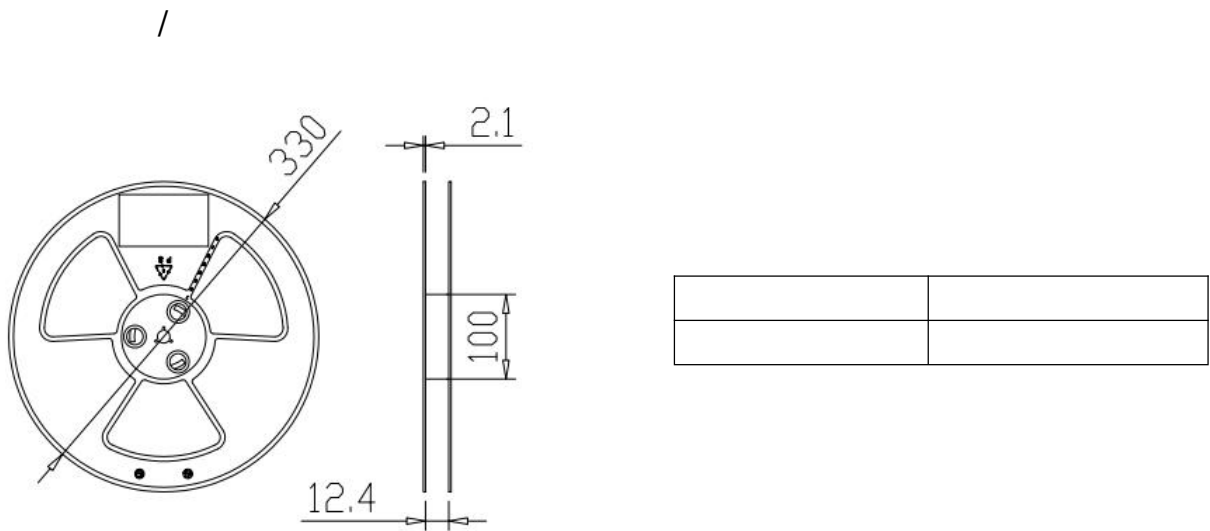

| ITEM | W | A0 | B0 | K1 | K0 | P | F | E | D0 | D1 | P0 | P2 | T |
|-----------|------|----------------------|----------------------|----|----------------------|----------------------|----------------------|----------------------|--------------------------|--------------------------|---------------------|---------------------|----------------------|
| DIM | 12.0 | $4.20^{+0.30/-0.30}$ | $5.70^{+0.10/-0.10}$ | -- | $2.70^{+0.10/-0.10}$ | $8.00^{+0.10/-0.10}$ | $5.50^{+0.10/-0.10}$ | $1.75^{+0.10/-0.10}$ | $\phi 1.5^{+0.10/-0.00}$ | $\phi 1.5^{+0.10/-0.10}$ | $4.0^{+0.10/-0.10}$ | $2.0^{+0.10/-0.10}$ | $0.30^{+0.05/-0.05}$ |
| ALTERNATE | | | | | | | | | | | | | |

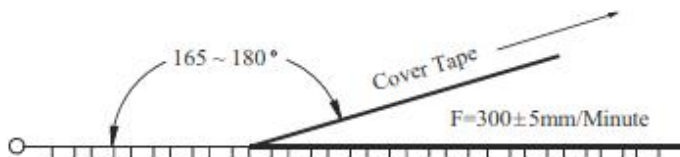

/

| Item | Data | Remark |
|---------------------|-----------|---|
| Cover tape adhesion | 10 ~ 100g | Carrier tape and cover tape open angle 165 ~ 180° F=300±5mm/minute |



| | | | |
|---|-----------------------------------|--|----|
|  TRX 专注电容器廿年 | SMD- 2 SMD 2 . . | | |
| | /N | | /D |
| | /E | | /P |

/ -

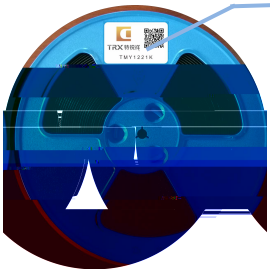

标签



料号

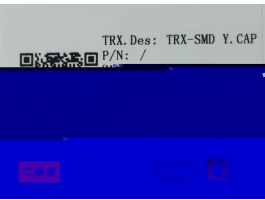



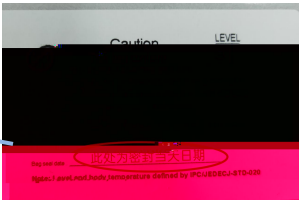

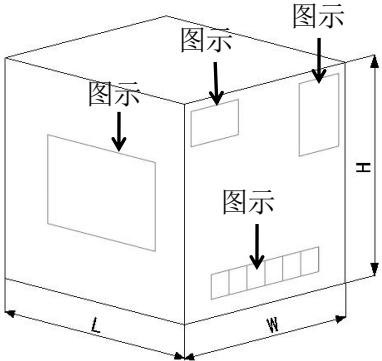

| | |
|--|--|
| | |
| | |
| | |
| | |
| | |
| | |
| | |
| | |

/O -





图示 /



图示 /



图示 /

| | | | |
|--|--|--|--|
| | | | |
| | | | |

/P :



/



/





" "

R

| | | | |
|---|-----------------------------------|--|----|
|  | SMD- 2 SMD 2 . . | | |
| | /N | | /D |
| | /E | | /P |

12. /A

①

②