

\_\_\_\_\_

\_\_\_\_\_

\_\_\_\_\_

\_\_\_\_\_





**TRX 特锐祥**  
专注电容器材料





	<b>SMD- 1</b> <b>SMD 1 . .</b>		
	/N		/D
	/E		/P

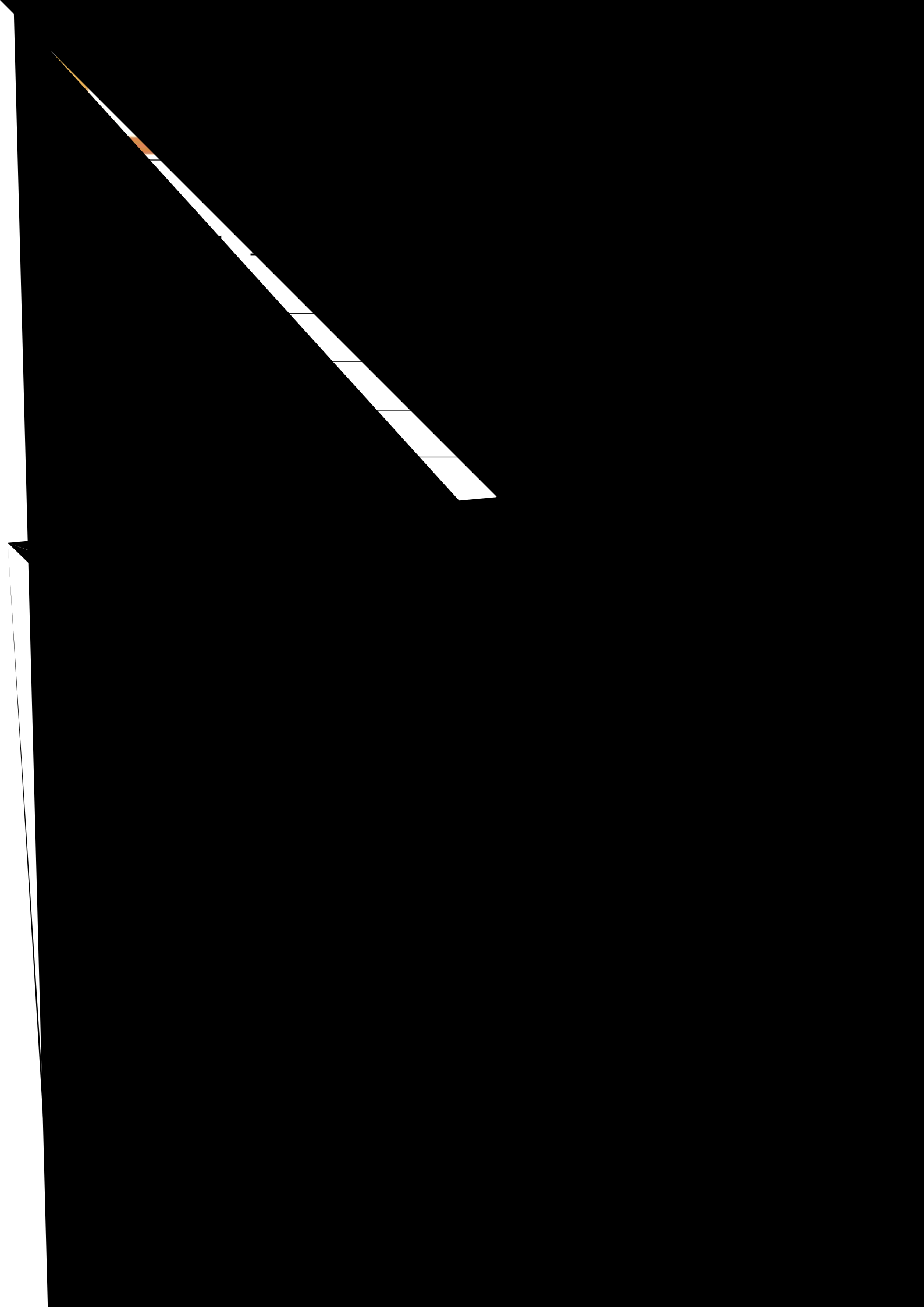







SMD- 1  
SMD 1 . .

/N

Yf



 <b>TRX</b> 专注电容器廿年	<b>SMD- 1</b>		
	<b>SMD 1 . .</b>		
	/N		/D
/E		/P	

/

/

**7.                    /P**





SMD- 1  
SMD 1 . .

/N

/D

/E

/P

±





 <b>TRX</b> 专注电容器廿年	<b>SMD- 1</b>		
	<b>SMD 1 . .</b>		
	/N		/D
/E		/P	

			± ±
			± ±
			±
			± ±
			± ±
			±

8. /C

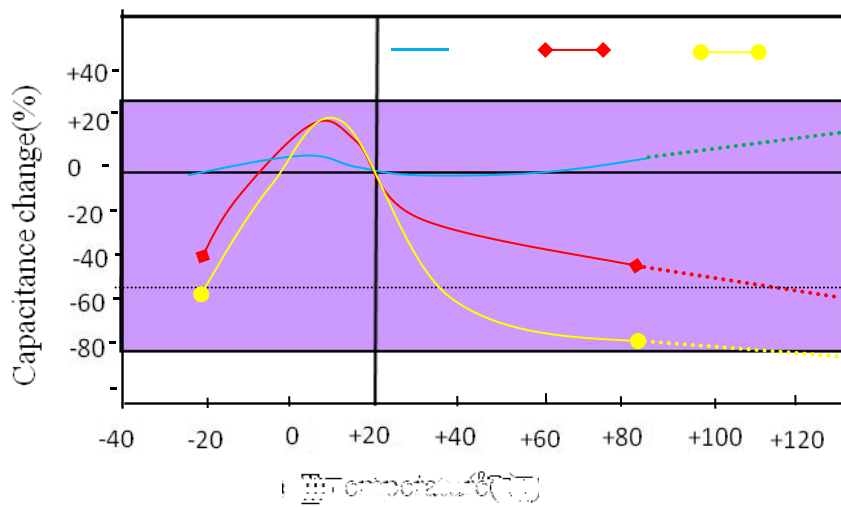





SMD- 1  
SMD 1 . .

/N

/D

/E

/P

11. /P

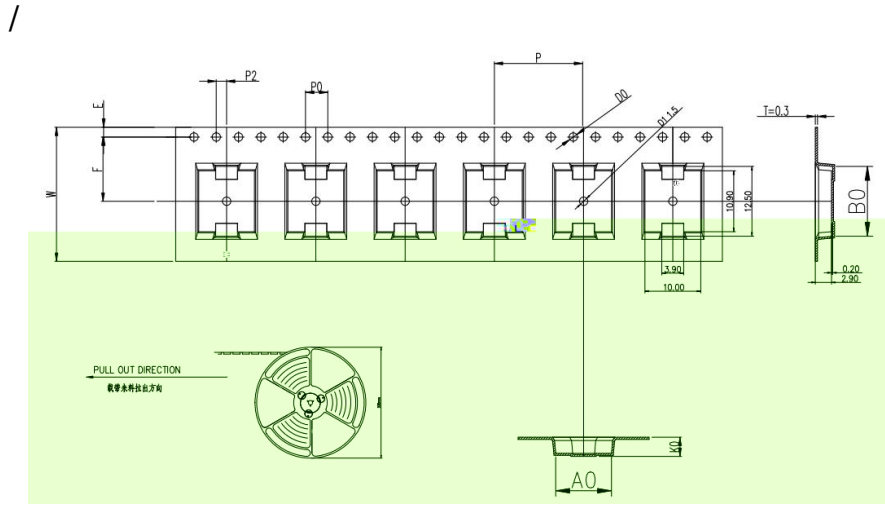

ITEM	W	A0	B0	K1	K0	P	F	E	D0	D1	P0	P2	T
DIM	24.0	$^{+0.30}_{-0.30}$	$^{+0.10}_{-0.10}$	$^{+0.10}_{-0.10}$	$^{+0.10}_{-0.10}$	$^{+0.10}_{-0.10}$	$^{+0.10}_{-0.10}$	$^{+0.10}_{-0.10}$	$^{+0.10}_{-0.00}$	$^{+0.10}_{-0.00}$	$^{+0.10}_{-0.10}$	$^{+0.10}_{-0.10}$	$^{+0.05}_{-0.05}$
ALTERNATE													

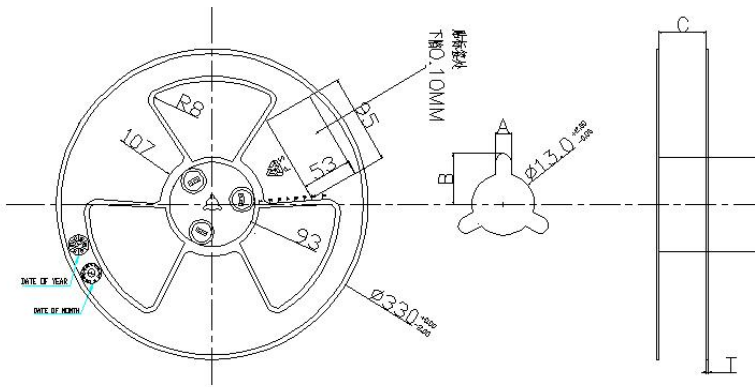

SPEC	A±0.3	B±0.5	C $^{+0.5}_{-0.0}$	D±0.5	T±0.2
24	2.3	10.75	24.4	Ø97	2.2

Item	Data	Remark
Cover tape adhesion	10 ~ 100g	Carrier tape and cover tape open angle 165 ~ 180° F=300± 5mm/minute

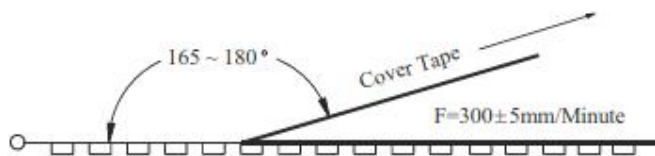



 <b>TRX</b> 专注电容器廿年	<b>SMD- 1</b>		
	<b>SMD 1 . .</b>		
	/N		/D
		/P	

/ -





TRX 特锐祥  
TGY1102K





TRX Des: TRX-SMD Y. CAP  
P/N: /  
QM Mfr: TGY1102K  
D/C: 2021.11.15  
LOT. NO: BSC2108015002  
QTY: 1000 PCS  
SPEC: SMD-Y1Y5P102K/AC400V





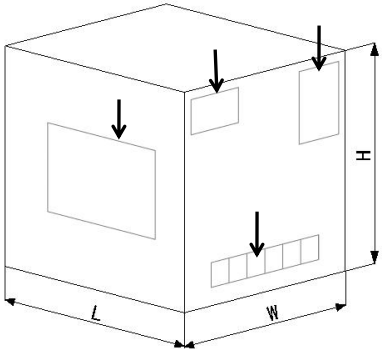

/O -













/
/
/

/P :









/
/

" "

R

