



---

---

---

## 一级代理商：

深圳市弗瑞鑫电子有限公司  
地址：深圳市宝安区西乡大道 号金源商务大厦B座三楼  
： -  
A : -  
[www.frxelec.com](http://www.frxelec.com)

• •

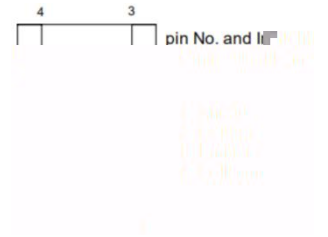

( )

- ( )

			*			

•



•

- - - - ( )

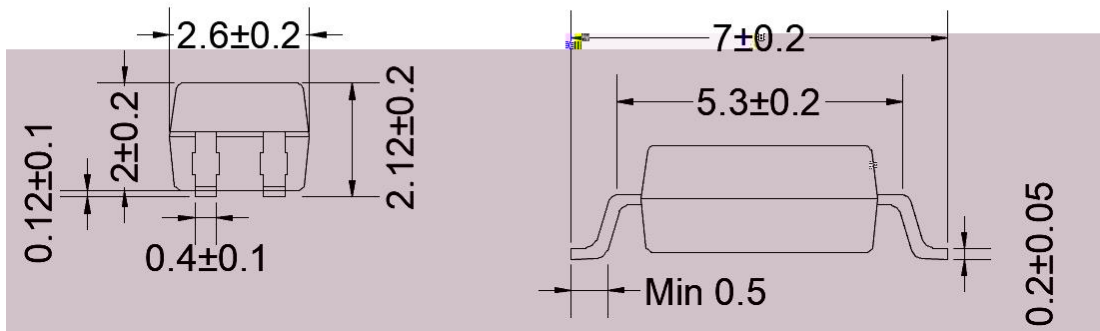
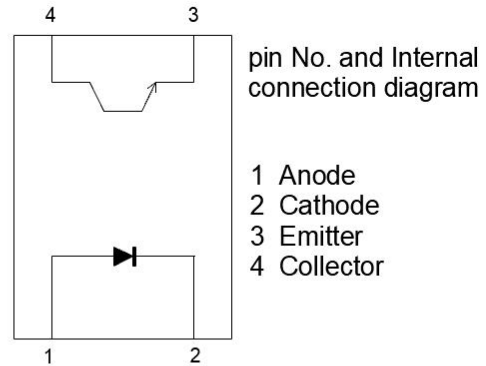
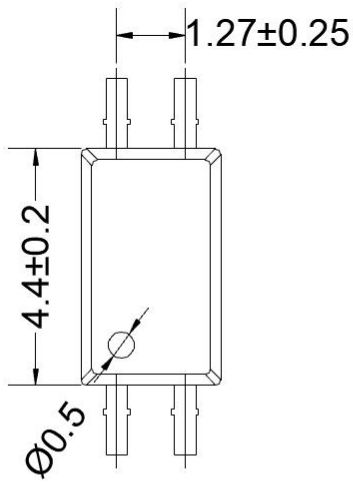

( ) ( )

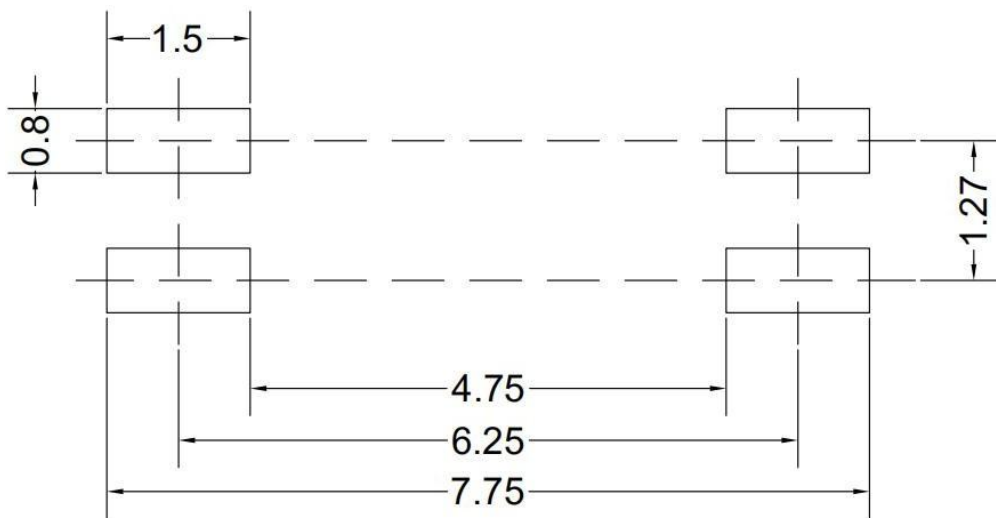

( ) - -

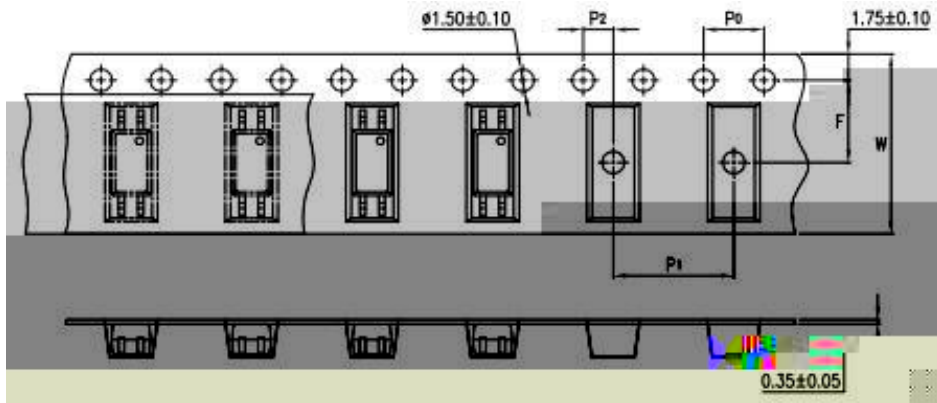

( ) - -

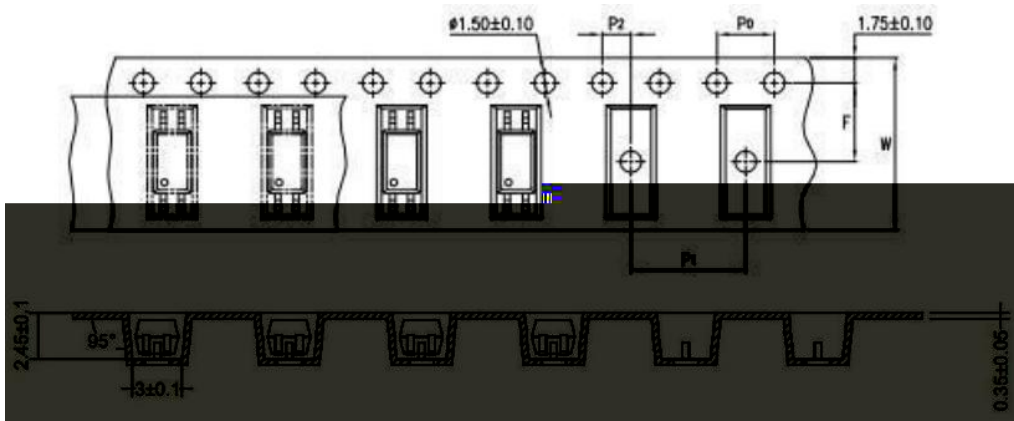





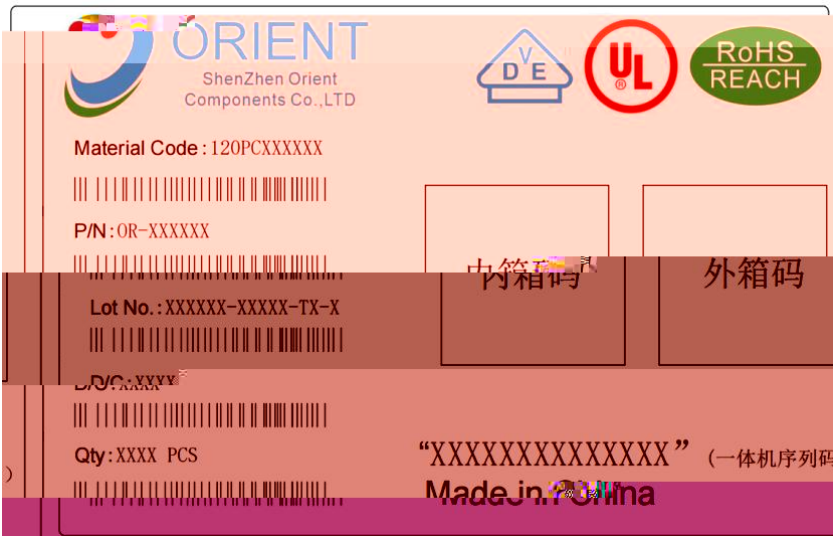

( )

( )



**ORIENT**  
 ShenZhen Orient Components Co.,LTD

Material Code : 120PCXXXXXX

|||||

P/N : OR-XXXXXX

|||||

Lot No. : XXXXXX-XXXXX-TX-X

|||||

Qty : XXXX PCS

|||||

“XXXXXXXXXXXXXXXXXX” (一体机序列码)

Made in China

内箱码

外箱码





( )

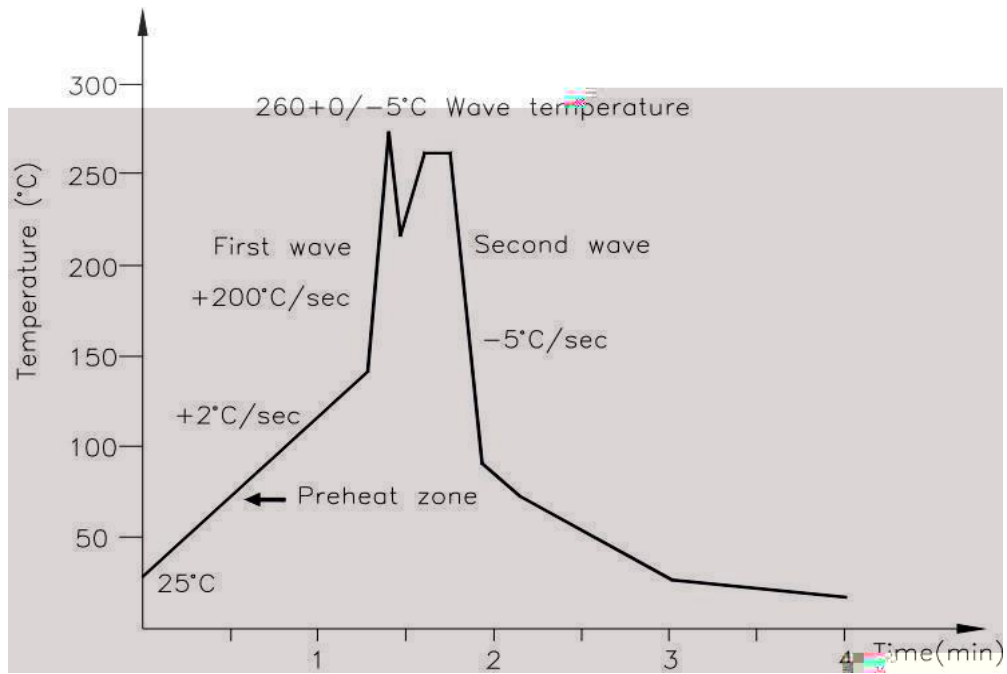

( )

--	--

Figure 1. Collector Power Dissipation vs. Ambient Temperature

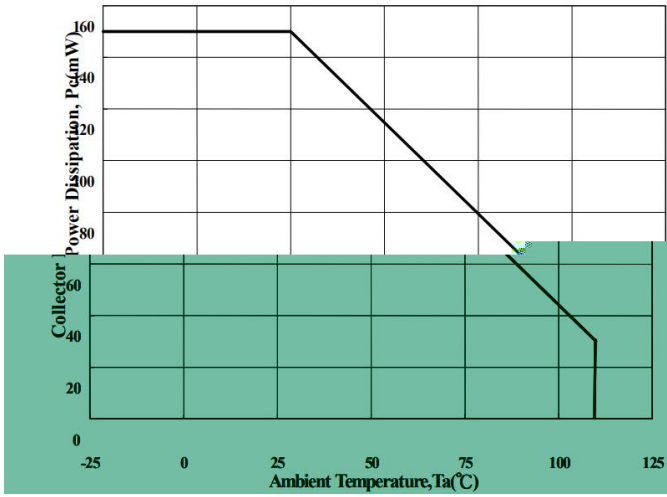

Figure 2. Forward Current vs. Ambient Temperature

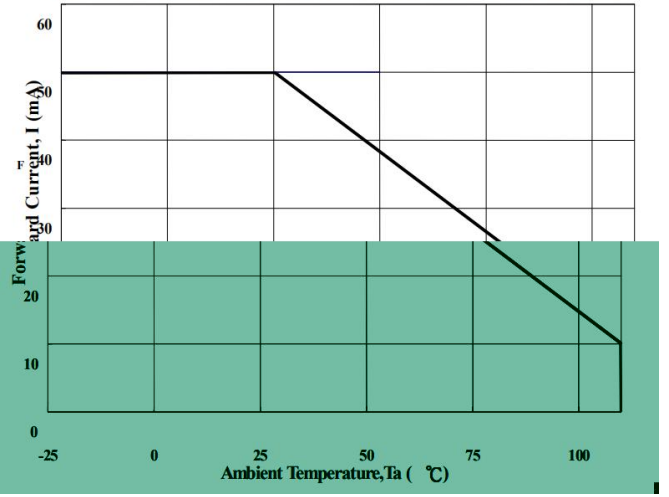

Figure 3. Forward Current vs. Forward Voltage

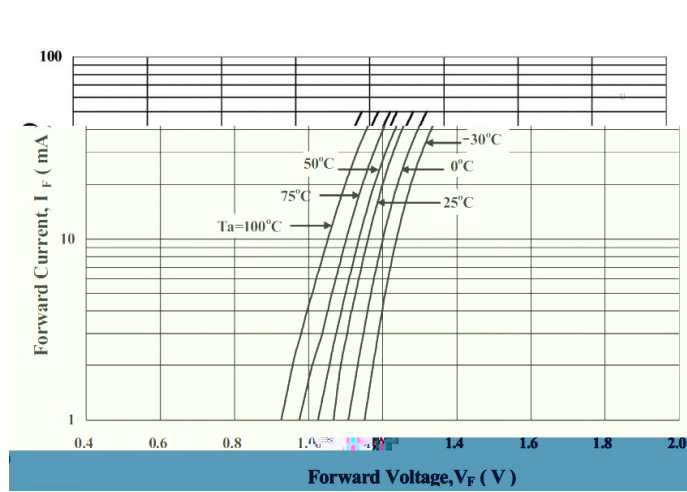

Figure 4. Forward Voltage Temperature Coefficient vs. Forward Current

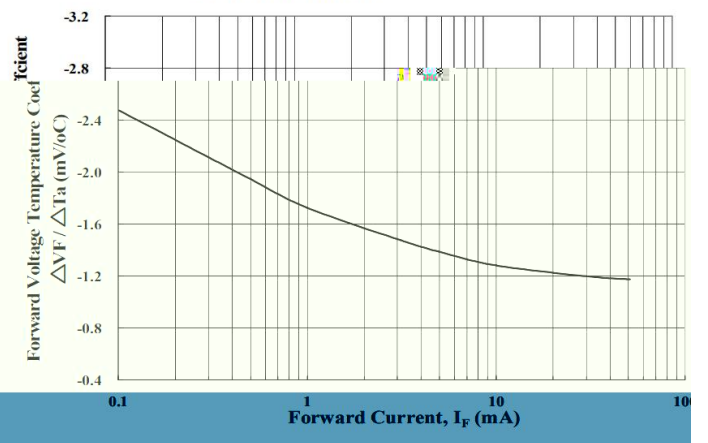

Figure 5. Pulse Forward Current vs. Duty Cycle Ratio

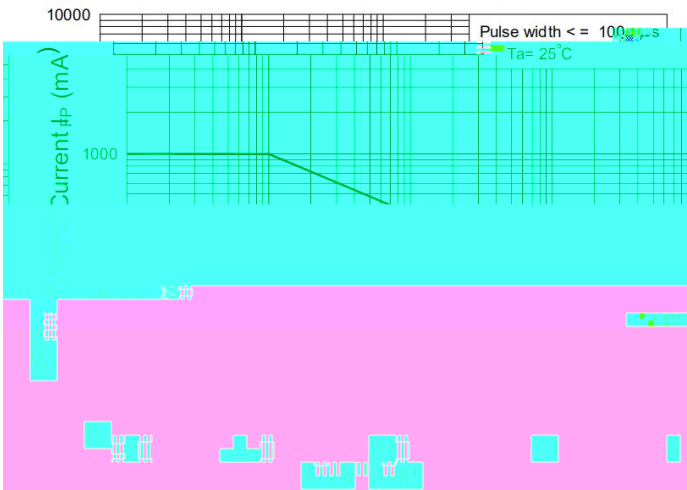

Figure 6. Pulse Forward Current vs. Pulse Forward

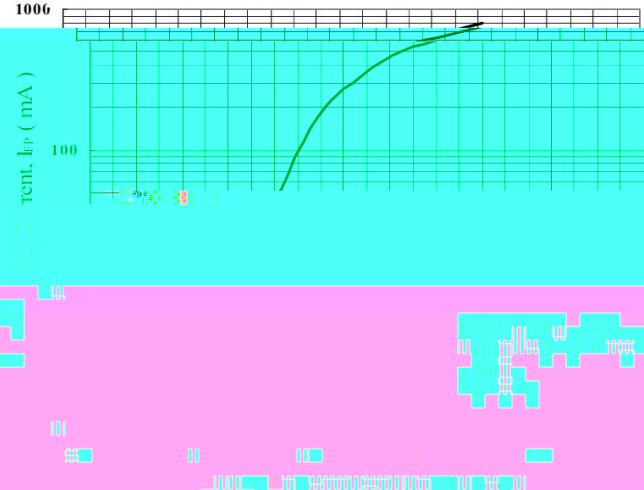

Figure 7. Collector-Emitter Saturation Voltage vs. Forward

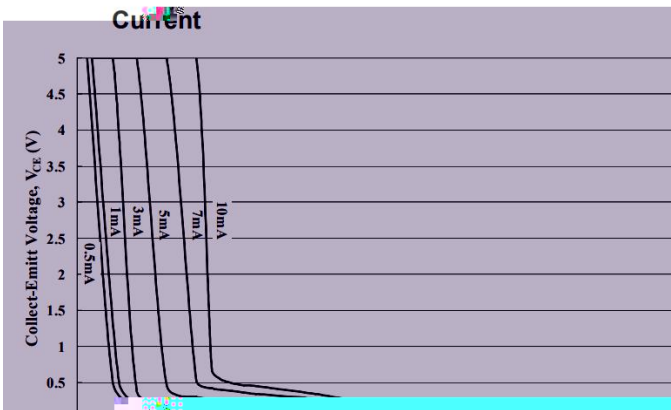

Figure 8. Collector Current vs. Collector-Emitter

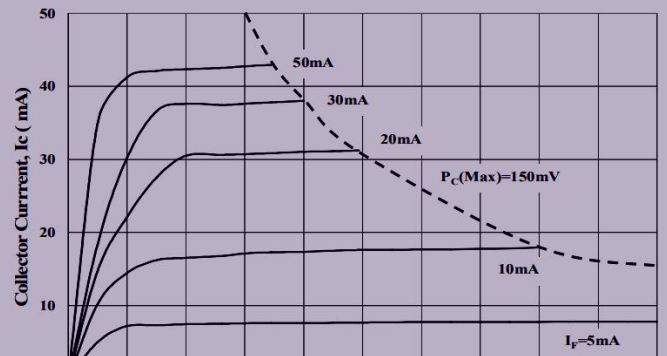

Figure 9. Collector Current vs. Small Collector-Emitter

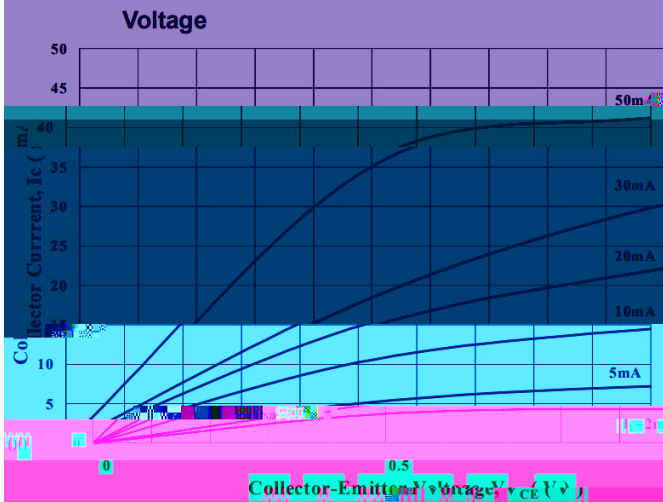

Figure 10. Normalized CTR vs. Forward Current

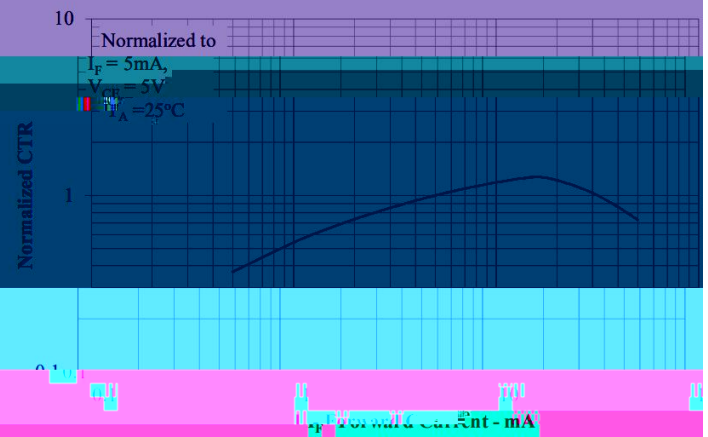

Figure 11. Collector Dark Current vs. Ambient Temperature

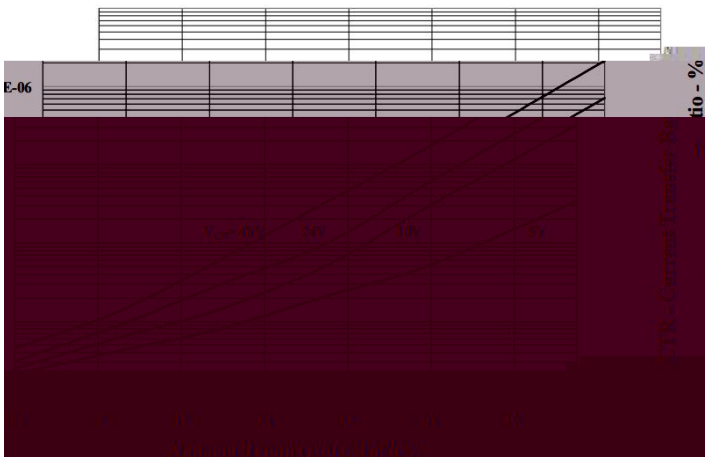
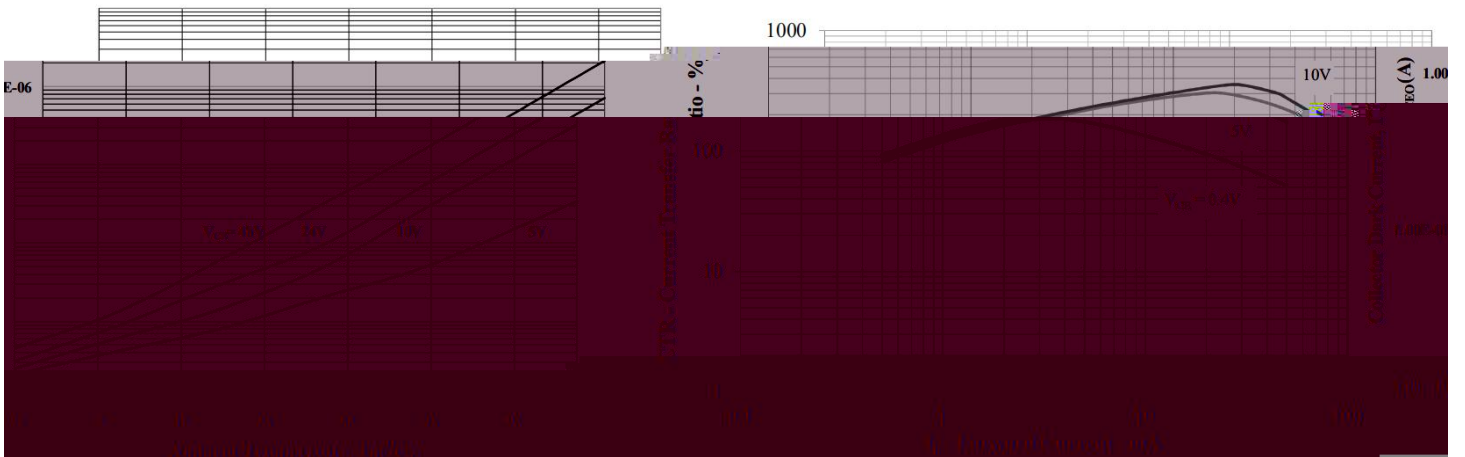

Figure 12. Current Transfer Ratio vs. Forward Current



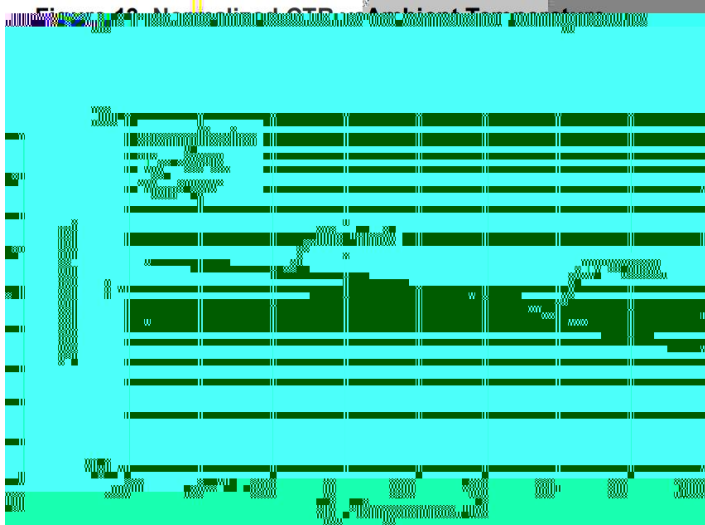

Figure 15. Collector Current vs. Ambient Temperature

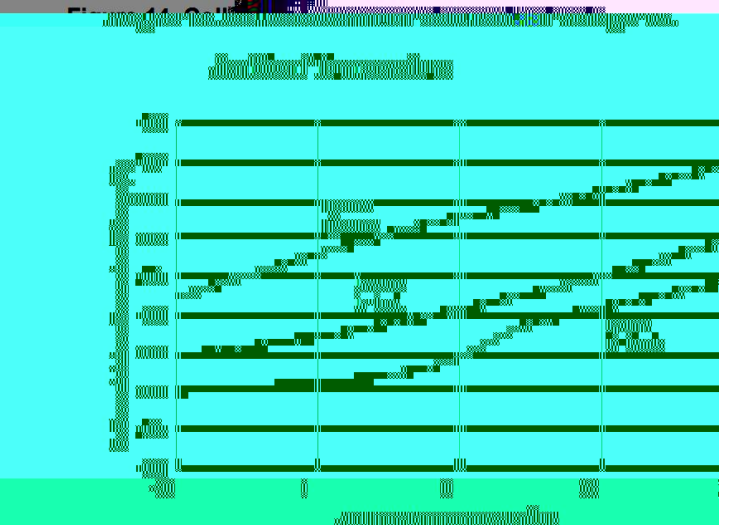

Figure 16. Switching Time vs. Load Resistance

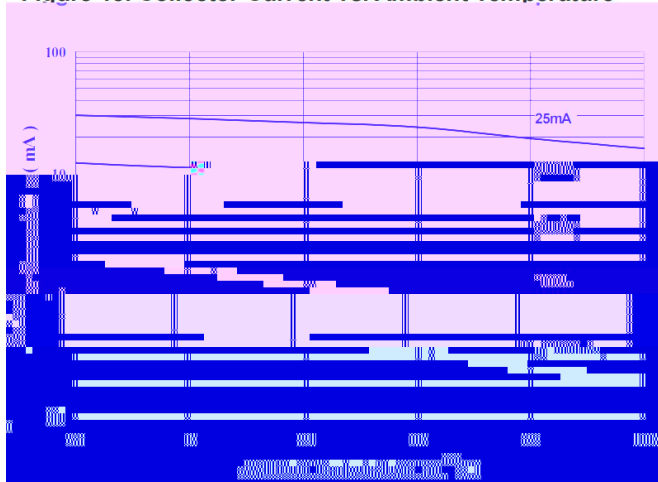

Figure 17. Switching Time vs. Ambient Temperature

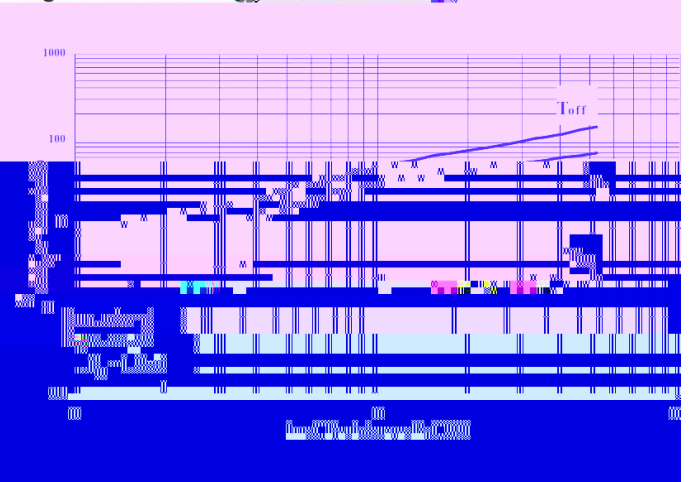

Figure 18. Frequency Response

