



规格承认书

—

prepare	
check	
approve	



TRX电容一级代理商

深圳市弗瑞鑫电子有限公司

Add: 深圳市宝安区西乡大道302号金源商务大厦B座3楼

Tel: 0755-29563634

Fax: 0755-27447020

 TRX 专注电容器廿年	SMD Y SMD Y1 a.c. ceramic capacitors			
	/Number		/Date	
	/Edition		/Page	

 TRX 专注电容器廿年	SMD Y SMD Y1 a.c. ceramic capacitors		
	/Number		/Date
	/Edition		/Page

1. /Product Name

T M Y1 101 K
 ① ② ③ ④ ⑤



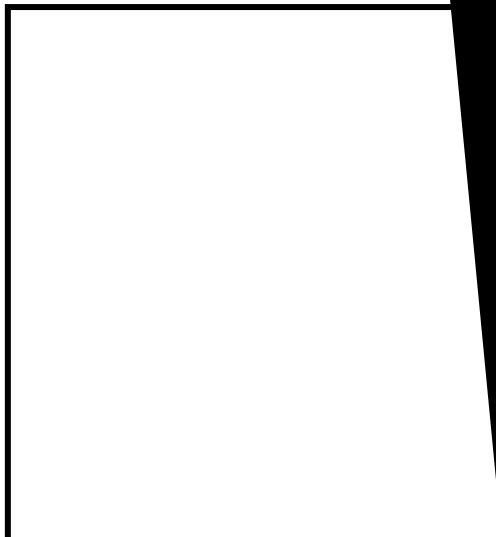

①		
②		
③		
④		
⑤		

2. /Product marking



 TRX 专注电容器廿年	SMD Y		
	SMD Y1 a.c. ceramic capacitors		
	/Number		/Date
/Edition		/Page	

/Explanation	
	
	
	
	
	

3. /Date code

↓	↓				
		↓	↓		

4. /Certificates

certificates			

5. / Product structure

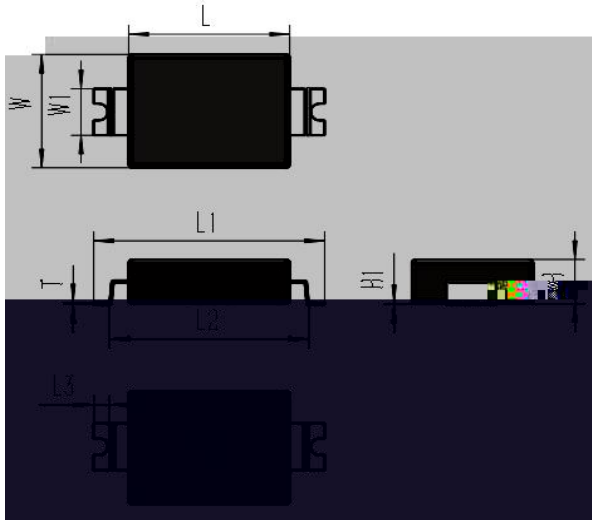

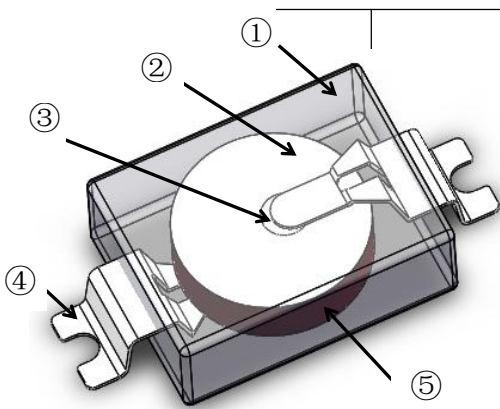

④		
⑤		

/Number		/Date	
/Edition		/Page	

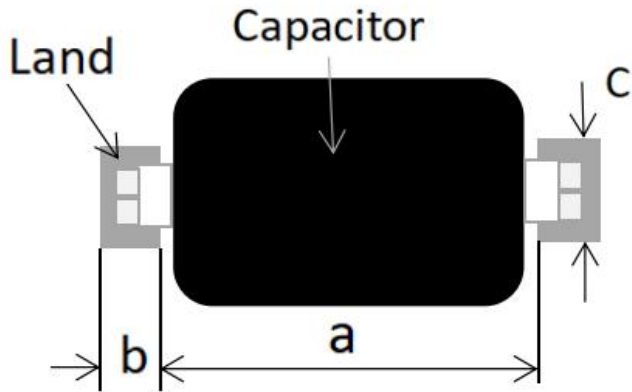

6. / Soldering condition

/

°
°C
°

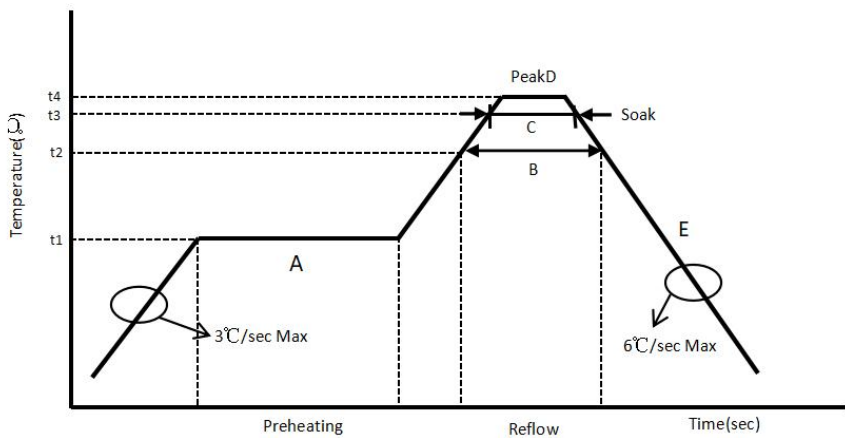

	SMD Y SMD Y1 a.c. ceramic capacitors		
	/Number		/Date
	/Edition		/Page

/

°
°C
°
°
°

/

7. / Performance and test methods

 TRX 专注电容器廿年	SMD Y SMD Y1 a.c. ceramic capacitors		
	/Number		/Date
	/Edition		/Page



|



SMD Y
SMD Y1 a.c. ceramic capacitors

/Number

/Date

/Edition

/Page

SMD Y
SMD Y1 a.c. ceramic capacitors



/Number

/Date

/Edition

/Page

		△	
		△	
		△	
		△	
		△	
		△	
		△	
		△	
		△	
		△	

SMD Y
SMD Y1 a.c. ceramic capacitors



/Number		/Date	
/Edition		/Page	

			<p>Diagram illustrating the test setup for SMD Y1 a.c. ceramic capacitors. The setup includes a burner positioned at a 45-degree angle, a flame, a test specimen, tissue paper, and a wood board of approximately 10mm thickness. Dimensions are indicated: approximately 8mm for the specimen length and 200 ± 5mm for the distance from the burner to the specimen.</p>
--	--	--	---

 TRX 专注电容器廿年	SMD Y SMD Y1 a.c. ceramic capacitors		
	/Number		/Date
	/Edition		/Page



	SMD Y SMD Y1 a.c. ceramic capacitors		
	/Number		/Date
	/Edition		/Page

9. /Content of toxic and harmful substances control requirements



10. /Storage conditions

(1)

(2)

/
/

(3)

(4)

 TRX 专注电容器廿年	SMD Y SMD Y1 a.c. ceramic capacitors			
	/Number		/Date	
	/Edition		/Page	

11. /Prod□d

 TRX 专注电容器廿年	SMD Y SMD Y1 a.c. ceramic capacitors		
	/Number		/Date
	/Edition		/Page

/inner-packaging

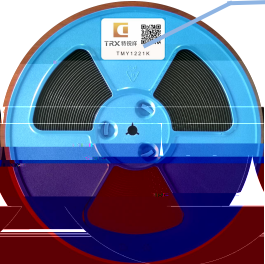

标签



料号

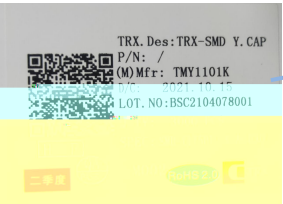

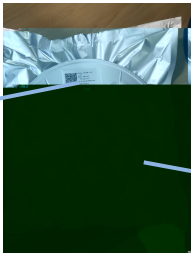

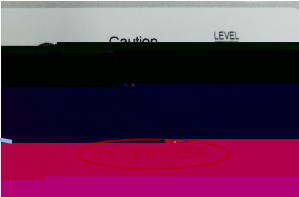

/Outer-packaging







图示 /

图示 /

图示 /

/Package sketch:



/



/





Remark

	SMD Y SMD Y1 a.c. ceramic capacitors			
	/Number		/Date	
	/Edition		/Page	

12. /Application notes

①

②

③

④

⑤

⑥