

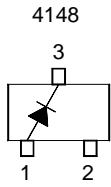

MMBD4148 / SE / CC / CA

Silicon Epitaxial Planar Switching Diode



Marking Code: 5D

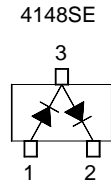

Marking Code: A7

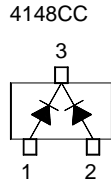

Marking Code: A4

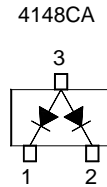

Marking Code: A1

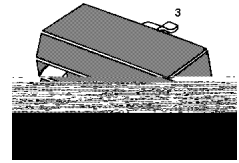

SOT-23 Plastic Package

Absolute Maximum Ratings ($T_a = 25\text{ }^\circ\text{C}$)

Parameter	Symbol	Value	Unit
Maximum Repetitive Reverse Voltage	V_{RRM}	100	V
Reverse Voltage	V_R	75	V
Average Rectified Forward Current	$I_{F(AV)}$	200	mA
DC Forward Current	I_{FM}	600	mA
Recurrent Peak Forward Current	I_{FRM}	700	mA
Non-repetitive Peak Forward Surge Current	I_{FSM}	1 2	A
		at $t = 1\text{ s}$ at $t = 1\text{ }\mu\text{s}$	
Total Device Dissipation	P_{tot}	350	mW
Operating Junction Temperature	T_j	150	$^\circ\text{C}$
Storage Temperature Range	T_{stg}	- 55 to + 150	$^\circ\text{C}$

Characteristics at $T_a = 25\text{ }^\circ\text{C}$

Parameter	Symbol	Min.	Max.	Unit
Forward Voltage at $I_F = 10\text{ mA}$	V_F	-	1	V
Reverse Breakdown Voltage at $I_R = 100\text{ }\mu\text{A}$ at $I_R = 5\text{ }\mu\text{A}$	$V_{(BR)R}$	100 75	- -	V
Reverse Current at $V_R = 20\text{ V}$ at $V_R = 75\text{ V}$ at $V_R = 20\text{ V}, T_a = 150\text{ }^\circ\text{C}$	I_R	- - -	25 5 50	nA μA μA
Reverse Recovery Time at $I_F = 10\text{ mA}, V_R = 6\text{ V}, I_{RR} = 1\text{ mA}, R_L = 100$	t_{rr}	-	4	ns
Total Capacitance at $V_R = 0\text{ V}, f = 1\text{ MHz}$	C_T	-	4	pF

Typical Characteristics

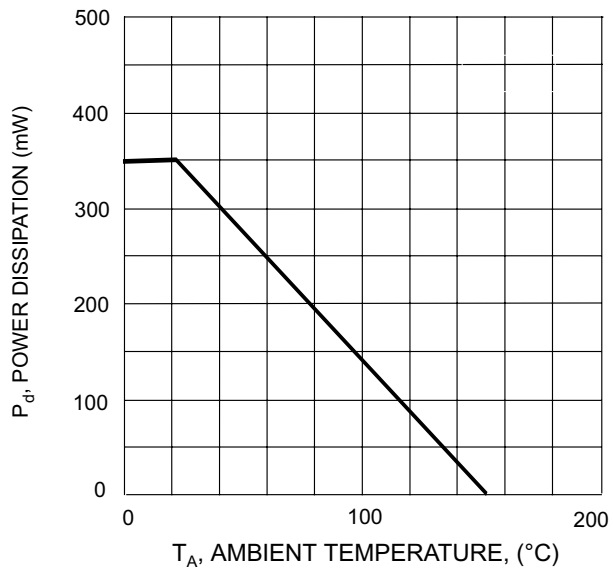

Fig. 1 Power Derating Curve

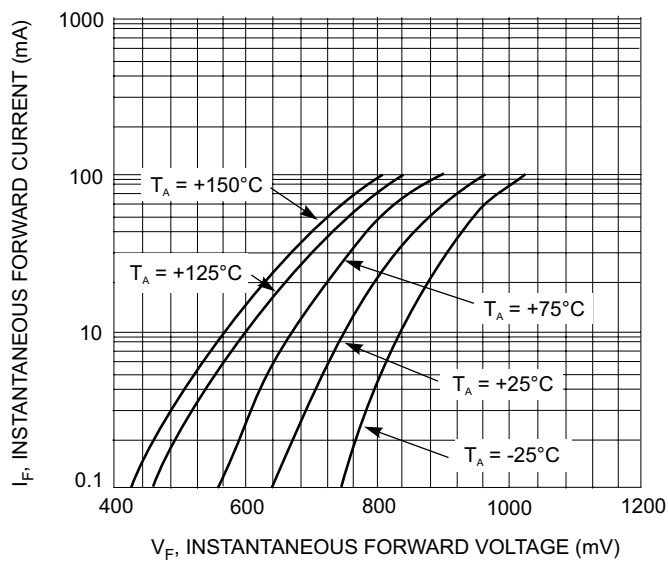
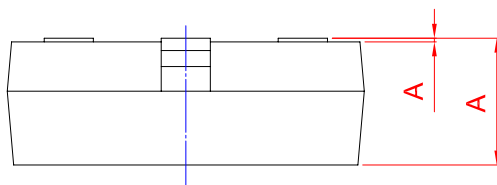
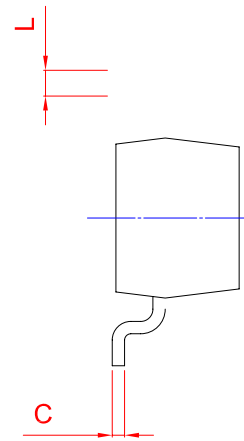
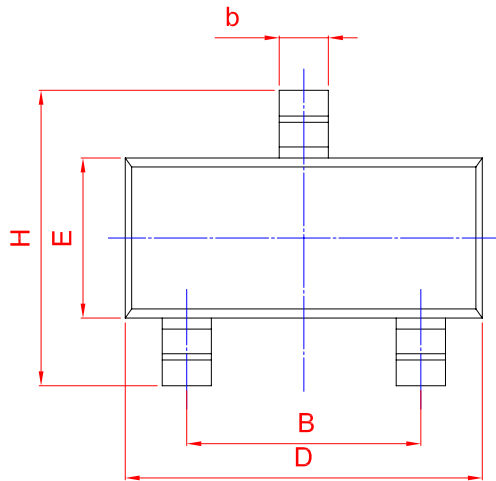
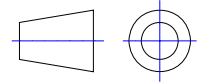

Fig. 2, Typical Forward Characteristics



UNIT	A				D	E		A1	
mm	1.								