

# 深圳市弗瑞鑫电子有限公司

## 规格承认书

/Specification for approval

客名 /CUSTOMER :

客号/CUSTOMER P.N. \_\_\_\_\_

号/TRX P.N. \_\_\_\_\_

型号/MODEL NO. \_\_\_\_\_

产 品	RoHS	REACH	Halogen 卤
保	■	■	■

制作/prepare	客 ( ) /customer to confirm (signed)
审 /check	<p style="text-align: center;">( 后, 壹份)</p> <p>/(signed subscription, please also one copy)</p>
准/approve	



TRX电容一级代理商

深圳市弗瑞鑫电子有限公司

Add:深圳市宝安区西乡大道302号金源商务大厦B座3楼

Tel:0755-29563634

Fax:0755-27447020

- 2

2 . .

/	-3-082	/	2021-11-15
/	A1	/	P 3 18

 <b>TRX</b> 专注电容器廿年	- 2			
	2 . .			
	/	-3-082	/	2021-11-15
	/	A1	/	P 4 18

## /CON EN

1.	P	N	-----	5
2.	P		-----	5-6
3.	D		-----	6
4.	C		-----	7
5.	P		-----	7-8
6.			-----	8-9
7.	P		-----	9-14
8.	C		-----	14
9.	C		-----	15
10.			-----	15
11.	P	P	-----	16-17
12.	A		-----	18

	- 2 2 . .			
	/	-3-082	/	2021-11-15
	/	A1	/	P 5 18

1. /

① ② ③ ④ ⑤ ⑥

N . C

E

①

L

	- 2 2 . .			
	/	-3-082	/	2021-11-15
	/	A1	/	P 6 18

3. /



		2020	M	1	01	1	01	16	16
		2021	N	2	02	2	02	17	17
2010	A	2022	P	3	03	3	03	18	18
2011	B	2023		4	04	4	04	19	19
2012	C	2024		5	05	5	05	20	20
2013	D	2025		6	06	6	06	21	21
2014	E	2026		7	07	7	07	22	22
2015	F	2027		8	08	8	08	23	23
2016	H	2028		9	09	9	09	24	24
2017	J	2029		10	10	10	10		

4. /

C		C	C
L/C L	L/C A 60384-14	E315719	AC300 ( . . . )
C C	GB/ 6346.14-2015	C C20001280609	AC300 ( . . . )
ENEC	EN 60384-14:2013/A1:2016	ENEC-03177	AC300 ( . . . )
KC	K60384-14	H 03034-21003A	AC250 ( . . . )

5. /

5.1 /P D

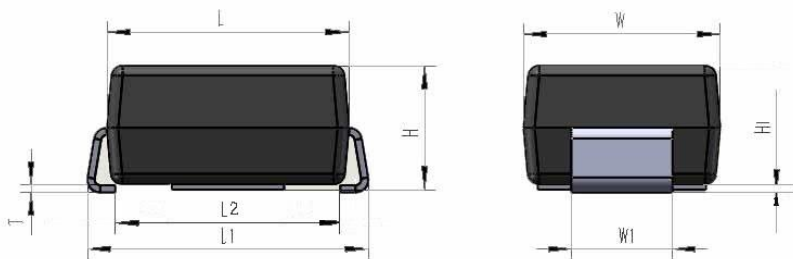

P		D		( )	
L	4.3 0.1			3.5 0.3	
L1	5.0 0.1	L2		4.0 0.1	
H	2.2 0.1	1		1.8 0.05	
H1	0.1 0.05			0.13 0.02	

5.2 /P

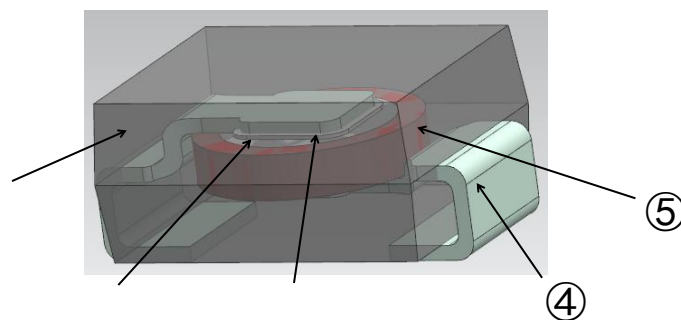

N .	P	M
①	C	E ( L94 -0) ( L94 -0)
②	E	/C
③		-P -A -P -A
④	L P	
⑤	D	C

- 2

2 . .

/

-3-082

/

2021-11-15

/

	- 2 2 . .			
	/	-3-082	/	2021-11-15
	/	A1	/	P 9 18

6.2 /F

280 °  
280°C .

30 °  
30 .

200 °  
200 .

P 200 .

180 °  
180 .

6.3 / I  
PCB/P B

PCB/P B,

400  
- 400 .

50  
50 .

5  
5 .

7. /

NO	I		
1	A	N L L	
2	D	5.1 5.1	



	- 2 2 . .			
	/	-3-082	/	2021-11-15
	/	A1	/	P 10 18

NO	I	
----	---	--



- 2 2 . .			
/	-3-082	/	2021-11-15
/	A1	/	P 11 18

NO	I			
8				150 180 C 90 30 P 150 180 C 90 30 . / : 230 C-260 C / : 60± 15 . / :4 15--35 45--75% H 24 2 L 15-35 , 45-75% H 24 2 , .
		NO.3 P NO.3		
	C	L:± 10% 5P:± 10% 5 :± 20% 5 :± 20%		
	D.F.	L: 1.0% 5P: 2.5% 5 : 2.5% 5 : 2.5%		
	I .	NO.7 P NO.7		
9		G	( 3 90% ) ( 3 90%),	(JI K 8101) (JI K 5902) ( 25%) ( ) I (JI K 8101) (JI K 5902) (25%) ( ) I 2 0.5 2 0.5 . : 245 10 C
10		N		: +125 3
		NO.3 P NO.3		: -40 3
	C	L:± 10% 5P: 10% 5 : 20% 5 : 20%		/ :5
	D.F.	L: 1.0% 5P: 2.5% 5 : 2.5% 5 : 2.5%		30 25 3 24 2
	I .	NO.7 P NO.7		C 24 2 25 3 .





NO	I		
16	C	N P NO.3 NO.7 N .3 N .7	$30 \pm 5\%$ $70 \pm 5\%$ $30 \pm 5\%$ $70 \pm 5\%$ /      : 23 5 $5 \pm 0.5$ $5 \pm 0.5$ . /      : 8
17			$30 \pm 5\%$ $70 \pm 5\%$ $30 \pm 5\%$ $70 \pm 5\%$ /      : 23 5 $5 \pm 0.5$ 10 $5 \pm 0.5$ 10 .

8. /

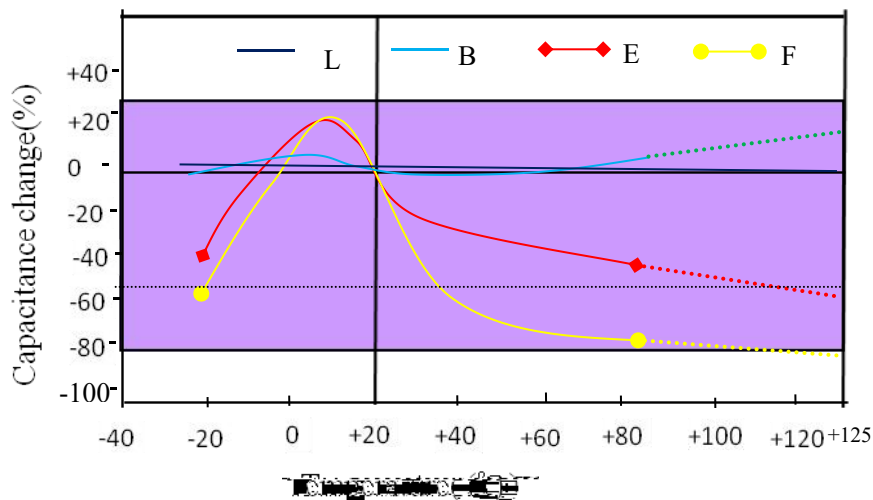

9. /

H 2.0 2011/65/E

EACH N 190 7/2006



	( ; )
/C	<100
/L	<1000
/M	<1000
/H	<1000
PBB /P	<1000
PBDE /P	<1000
+ + + /C +P +H +C +6( )	<100
/C	<900
/B	<900
+ /C +B	<1500
EACH H C HC ( HC) EACH	EACH

10. /

(1).

E ; , , ,  
. A , , , , ,

(2).

12

12

.  
/ : 10 30  
/H : 60%

(3).

168

168

HIC

. A

(4).

6

60 × 168

I

6

HIC

(60 168 )

 <b>TRX</b> 专注电容器廿年	- 2 2 . .			
	/	-3-082	/	2021-11-15
	/	A1	/	P 16 18

11. /  
11.1 /D

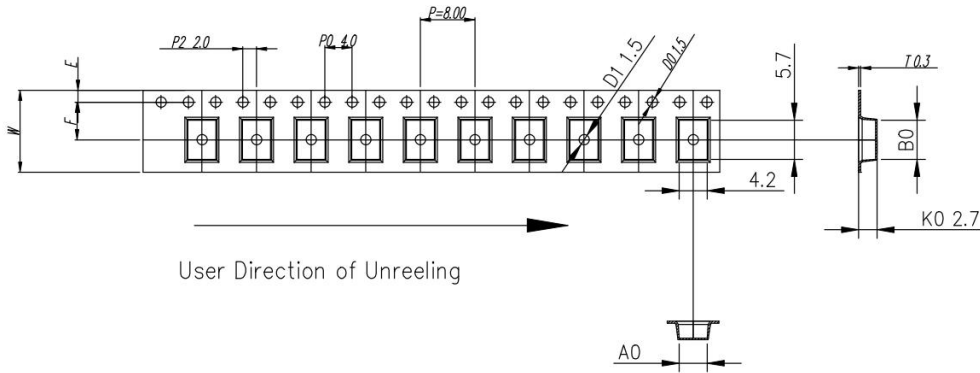

ITEM	W	A0	B0	K1	K0	P	F	E	D0	D1	P0	P2	T
DIM	12.0 $\pm 0.30$	4.2 $\pm 0.10$	5.70 $\pm 0.10$	--	2.70 $\pm 0.10$	8.00 $\pm 0.10$	5.50 $\pm 0.10$	1.75 $\pm 0.10$	$\phi 1.5$ $\pm 0.05$	$\phi 1.5$ $\pm 0.10$	4.0 $\pm 0.10$	2.0 $\pm 0.10$	0.30 $\pm 0.05$
ALTERNATE													

11.2 /D

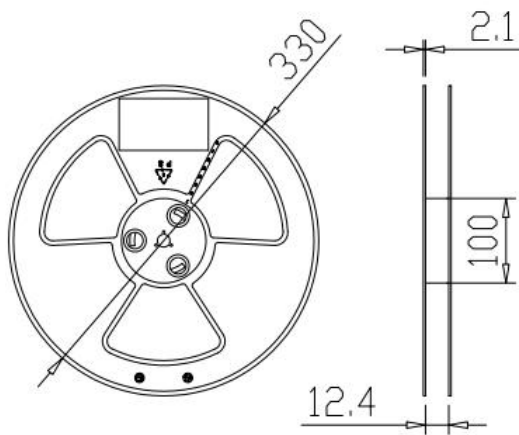

EEL	EEL I E
3000	13



11.3 /P

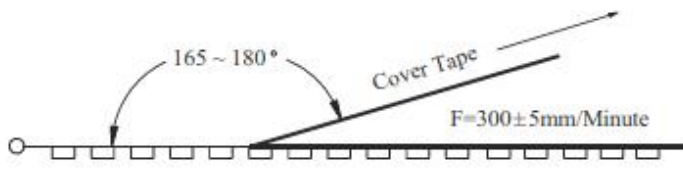



Item	Data	Remark
Cover tape adhesion	10 ~ 100g	Carrier tape and cover tape open angle 165 ~ 180° F=300±5mm/minute

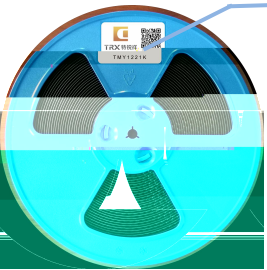

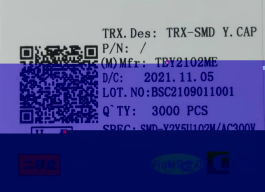
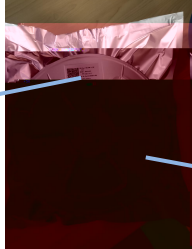
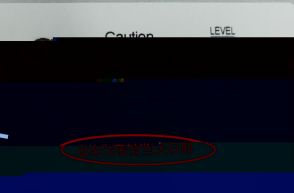

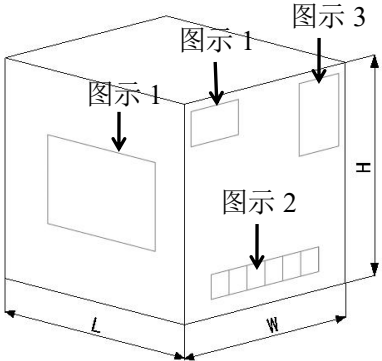

 <b>TRX</b> 专注电容器廿年	- 2 2 . .			
	/	-3-082	/	2021-11-15
	/	A1	/	P 17 18

11.4 /P P

/ -	 标签/L  料号   		/I
/ : 13 3.0KPC /	/I	料号	
/P	/L	/H	.D
			P/N
			M
			D/C
			L .N
			PEC

/ -	   		
	图示 1/F 1	图示 2/F 2	图示 3/F 3
	D ( )		O B
	L	H	45KPC 10.0KG
	355	294	

/ :	   			
	/O B	15 / /15 /B	( / / ) P (L/ /H) 1100*1100*90	( / / ) (L/ /H) 1100*1100*1600

1. " 5" 5 2. PALLE & APPING  
 3.50 :1. 5 4. / ' 5 ; 2. P & -  
 ; 3.50 ; 4. N



	- 2 2 . .			
	/	-3-082	/	2021-11-15
	/	A1	/	P 18 18

12. /

①.

A

②.

PCB

PCB

PCB

C