

## 规格承认书

—

\_\_\_\_\_

\_\_\_\_\_

prepare	
check	
approve	



TRX电容一级代理商  
深圳市弗瑞鑫电子有限公司

Add: 深圳市宝安区西乡大道302号金源商务大厦B座3楼  
Tel: 0755-29563634  
Fax: 0755-27447020





- 2 2 . .			
/		/	
/		/	

	- 2 2 . .		
	/		/
	/		/

1. /

$\overline{\text{①}}$   $\overline{\text{②}}$   $\overline{\text{③}}$   $\overline{\text{④}}$   $\overline{\text{⑤}}$   $\overline{\text{⑥}}$

①

	- 2 2 . .		
	/		/
	/		/

3. /



4. /

5. /





①		
②		
③		
④		
⑤		

- 2  
2 ..

/

/

/ 2

8

	- 2 2 . .		
	/		/
	/		/

/

°  
°C

°

°

°

/

7. /



	- 2 2 . .		
	/		/
	/		/





- 2  
2 ..

/

/

/

/

					±
		±			
		±			
		±			
		±			





			$\pm$ $\pm$ $\pm$ $\pm$ $\pm$
			$\pm$ $\pm$ $\pm$ $\pm$ $\pm$

8. /

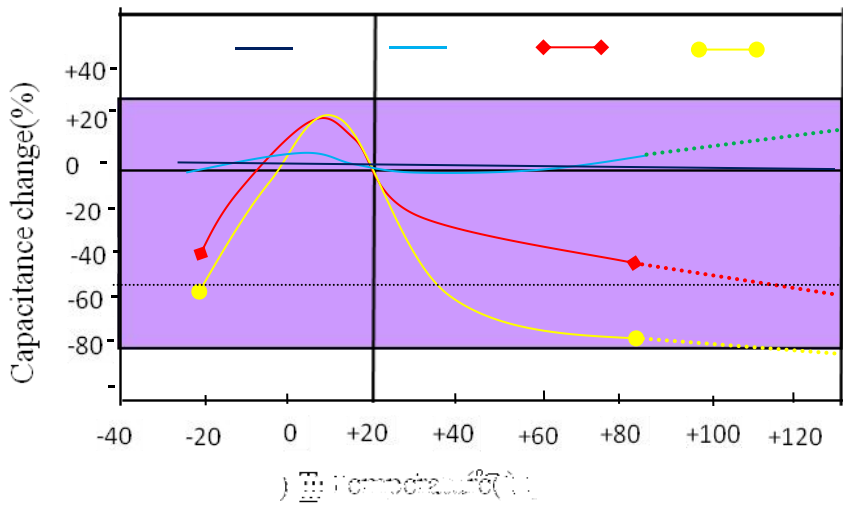



11. /  
/

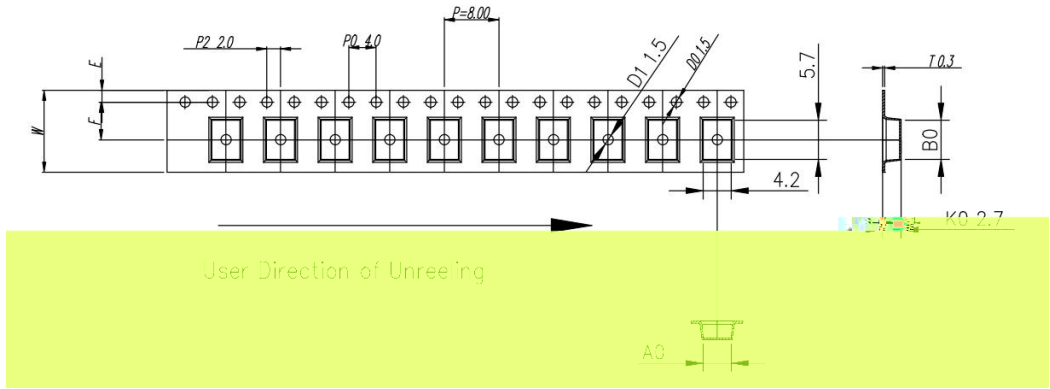



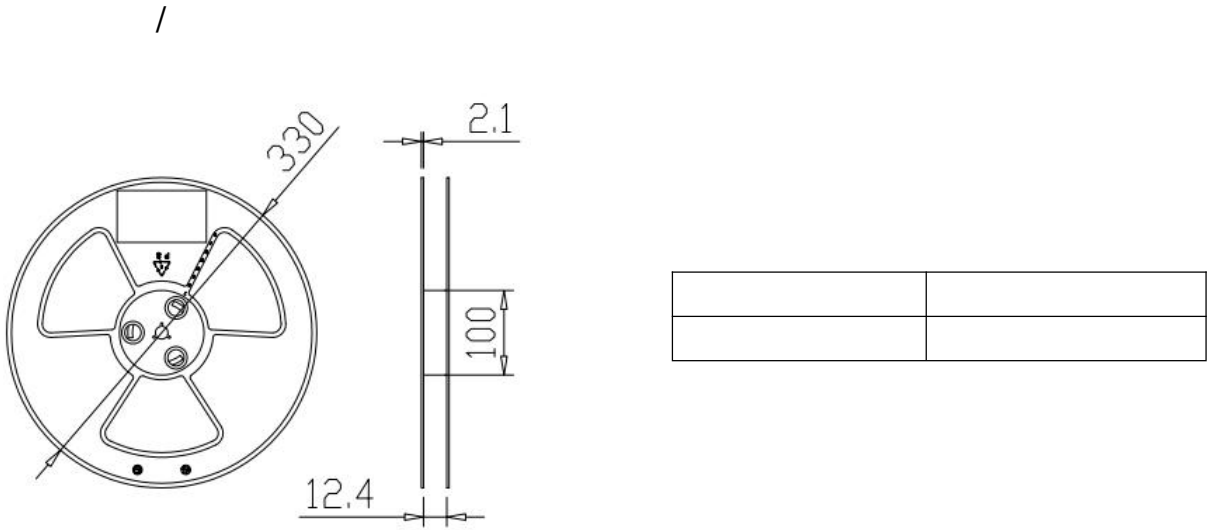

ITEM	W	A0	B0	K1	K0	P	F	E	D0	D1	P0	P2	T
DIM	12.0	$4.20^{+0.30/-0.30}$	$5.70^{+0.10/-0.10}$	--	$2.70^{+0.10/-0.10}$	8.00	$5.50^{+0.10/-0.10}$	1.75	$\phi 1.5^{+0.10/-0.00}$	$\phi 1.5^{+0.10/-0.10}$	4.00	2.00	0.30
ALTERNATE													

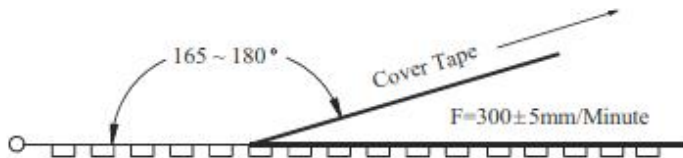

/

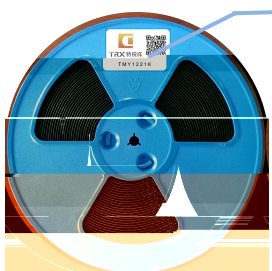
Item	Data	Remark
Cover tape adhesion	10 ~ 100g	Carrier tape and cover tape open angle 165 ~ 180° F=300±5mm/minute

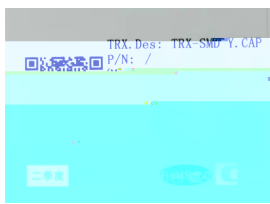
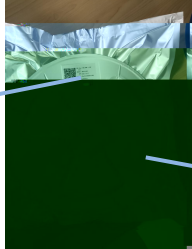

/ -			
 <p>标签</p>	 <p>料号</p>		
			

/ -			
	 <p>图示 /</p>	 <p>图示 /</p>	 <p>图示 /</p>

/ :			
			
/	/		

" "



	- 2 2 . .		
	/		/
	/		/

12. /

①

②