



FILE NO.	QC-T4-09
Ver:	1.0
Page	1/21



---

---

---

---

---





	FILE NO.	QC-T4-09
	Ver:	1.0
	Page	2/21



FILE NO.	QC-T4-09
Ver:	1.0
Page	3/21

1.1 UL94-V0 

Advanced packaging technology, packaging materials meet UL94-V0 

1.2 Compact structure, small size, space saving 

1.3 Superior high temperature and high humidity performance

1.4 Strong voltage resistance

1.5 SMD /  
SMD tray packaging, suitable for lead-free reflow soldering/wave soldering automatic placement

1.6 RoSH REACH H.F  
Comply with RoSH, REACH H.F

1.7 Safety certification:



1.8 ISO9001:2015 ISO9001:2015 Quality Management System

ISO14001:2015 ISO14001:2015 Environmental Management System

IAFT16949 IAFT16949 Automotive Quality Management System

2.1 LED circuit protectionLED

2.2 Industrial equipment

2.3 Communication equipment

2.4 Automotive Electronics



~~CMD 2 V1 V1 V5 D 100 K 5000000 C D~~

SMD

1

1

3

2

2

Y

ZL 2021 2 0745266.4

3

2

ZL 2021 2 1194394.0

Y1X1





	pF	
SL	10	SMD-1Y1X1SL100J500VAC
SL	22	SMD-1Y1X1SL220J500VAC
SL	47	SMD-1Y1X1SL470J500VAC
SL	56	SMD-1Y1X1SL560J500VAC
SL	68	SMD-1Y1X1SL680J500VAC
Y5P	100	SMD-1Y1X1Y5P101K500VAC
Y5P	110	SMD-1Y1X1Y5P111K500VAC
Y5P	120	SMD-1Y1X1Y5P121K500VAC
Y5P	150	SMD-1Y1X1Y5P151K500VAC
Y5P	200	SMD-1Y1X1Y5P201K500VAC
Y5P	220	SMD-1Y1X1Y5P221K500VAC

		FILE NO.	QC-T4-09
		Ver:	1.0
		Page	7/21

Y5P 270 SMD-1Y1X1Y5P271K500VAC

Y5P 330 SMD-1Y1X1Y5P331K500VAC

Y5P 390 SMD-1Y1X1Y5P391K500VAC

Y5P 470 SMD-1Y1X1Y5P471K500VAC

m



Y5U	820	SMD-1Y1X1Y5U821M500VAC
Y5U	1000	SMD-1Y1X1Y5U102M500VAC
Y5U	1500	SMD-1Y1X1Y5U152M500VAC
Y5V	1000	SMD-1Y1X1Y5V102M500VAC
Y5V	1500	SMD-1Y1X1Y5V152M500VAC
Y5V	2200	SMD-1Y1X1Y5V222M500VAC



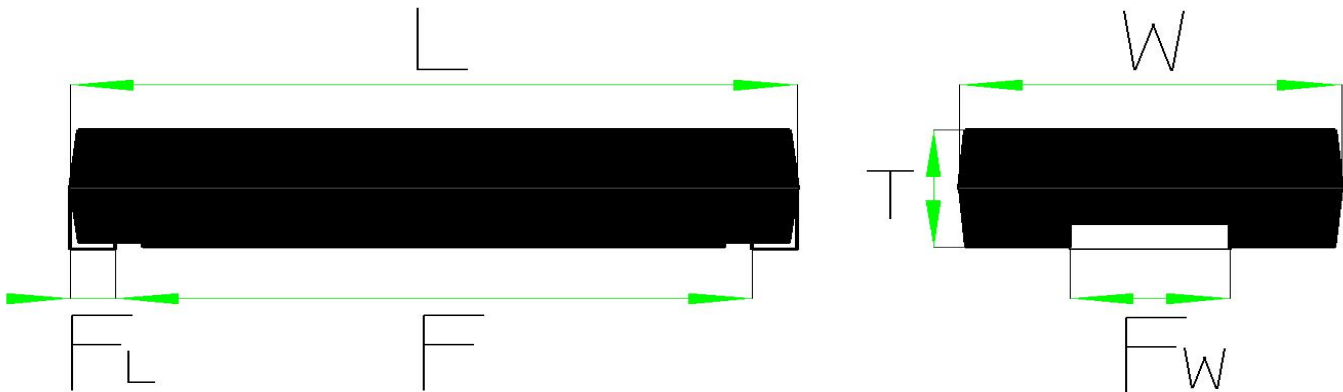

	L	W	T	F	$F_L$	$F_W$
500VAC	11.4 0.3	6.0 0.3	2.4 0.1	10 0.3	0.7 0.3	2.5 0.3

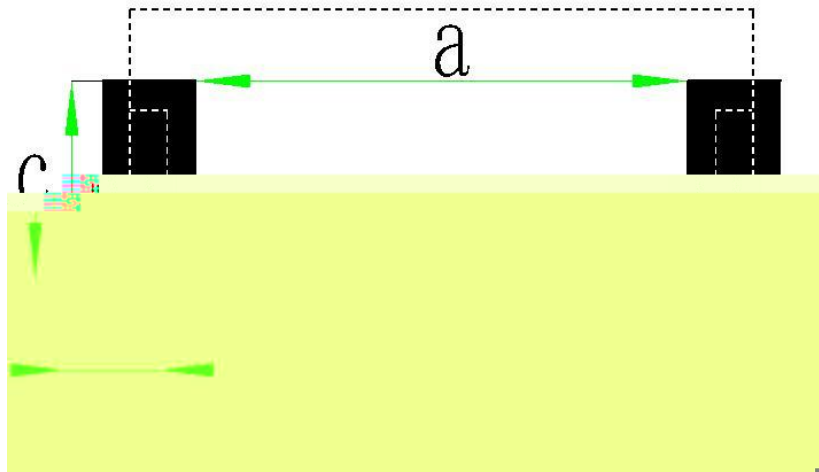

	a	b	C
11.4x6.0	9	1.7	3.6





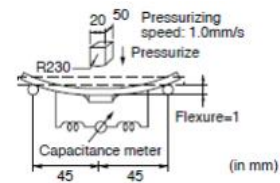
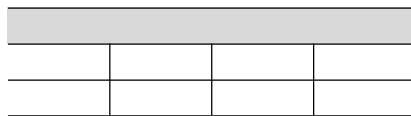
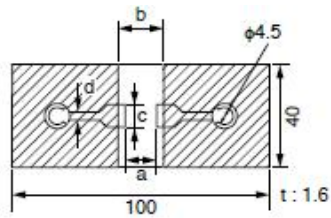
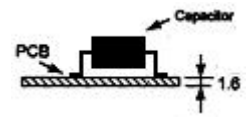





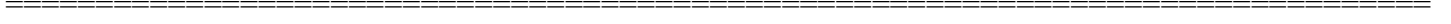

FILE NO.	QC-T4-09
Ver:	1.0
Page	13/21

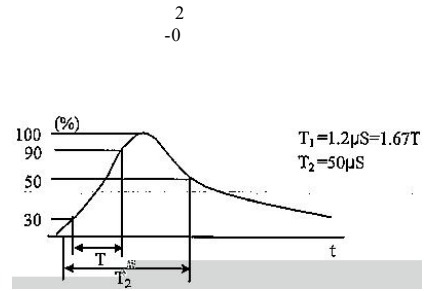



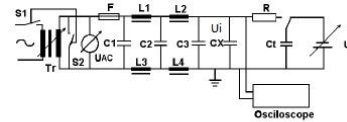

C1,2 :  $1\mu\text{F}\pm 10\%$ , C3 :  $0.033\mu\text{F}\pm 5\%$  10kV  
 L1 to L4 :  $1.5\text{mH}\pm 20\%$  16A Rod core choke  
 R :  $100\Omega\pm 2\%$ , Ct :  $3\mu\text{F}\pm 5\%$  10kV  
 UAc :  $U_R \pm 5\%$   $U_R$  : Rated voltage  
 Cx : Capacitor under test  
 F : Fuse, Rated 10A  
 Ut : Voltage applied to Ct



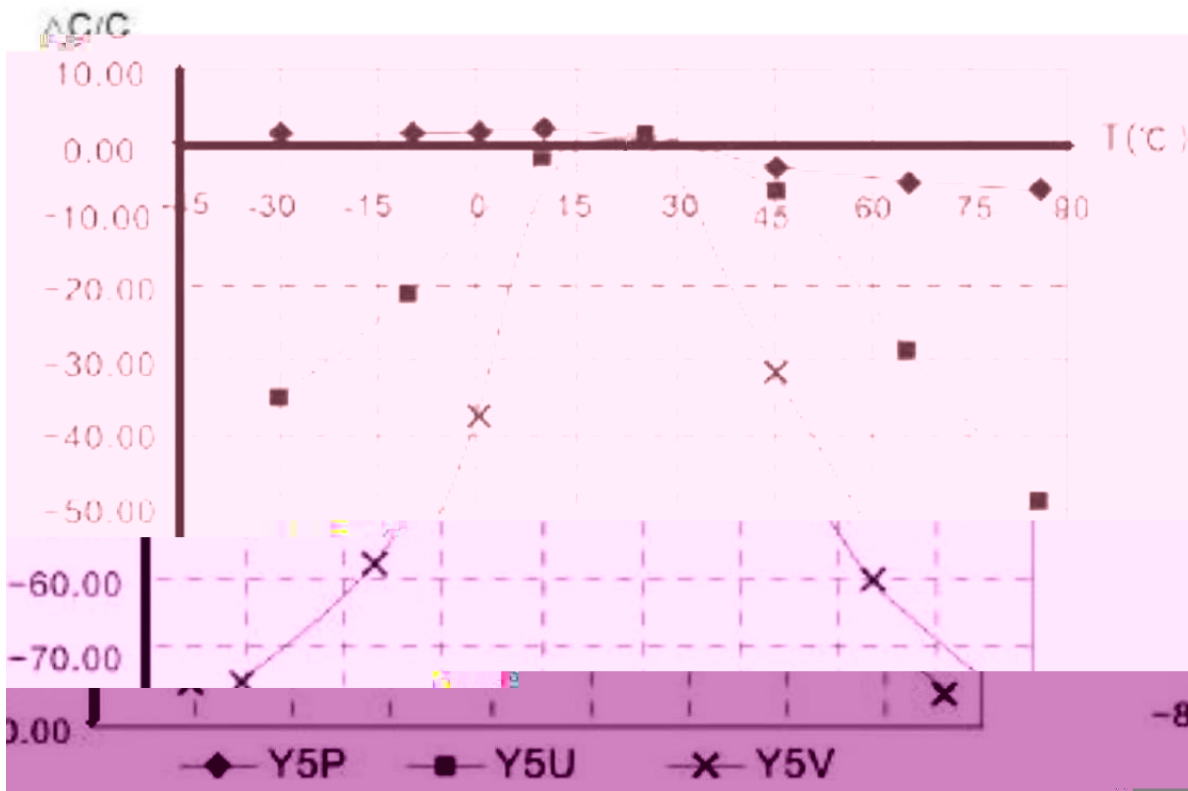
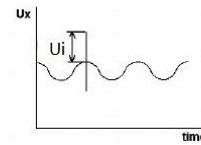

Taping Packaging

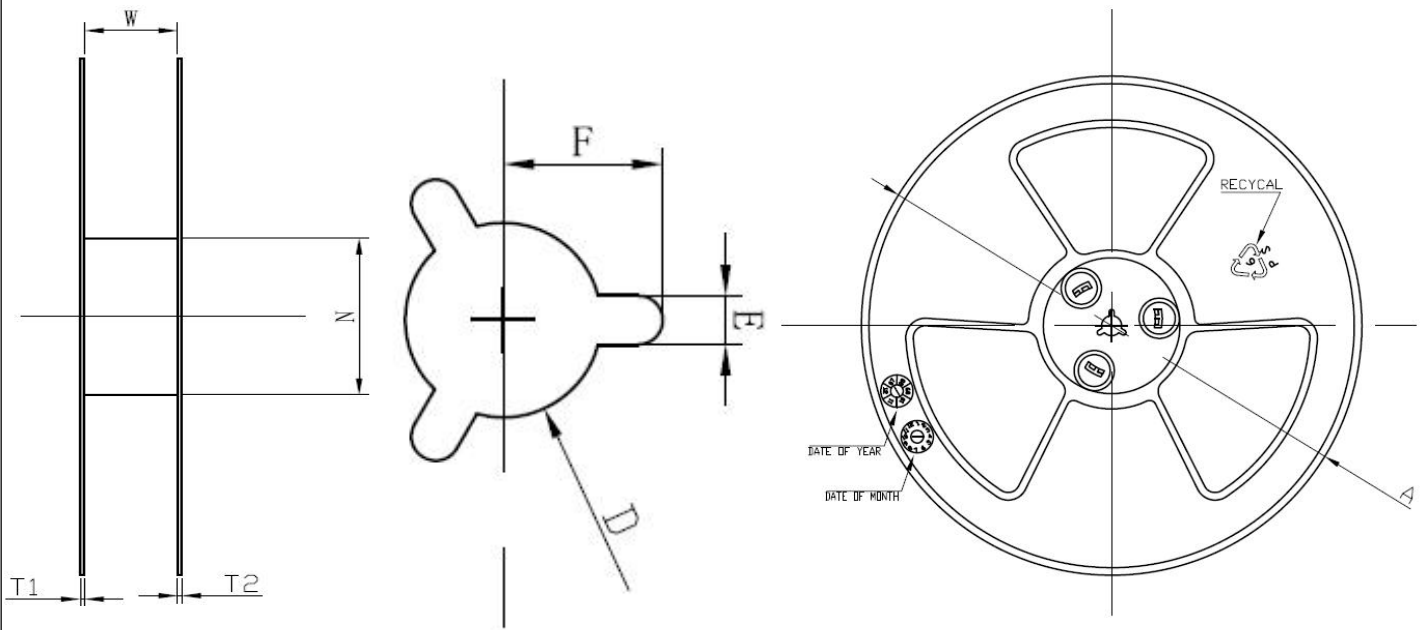
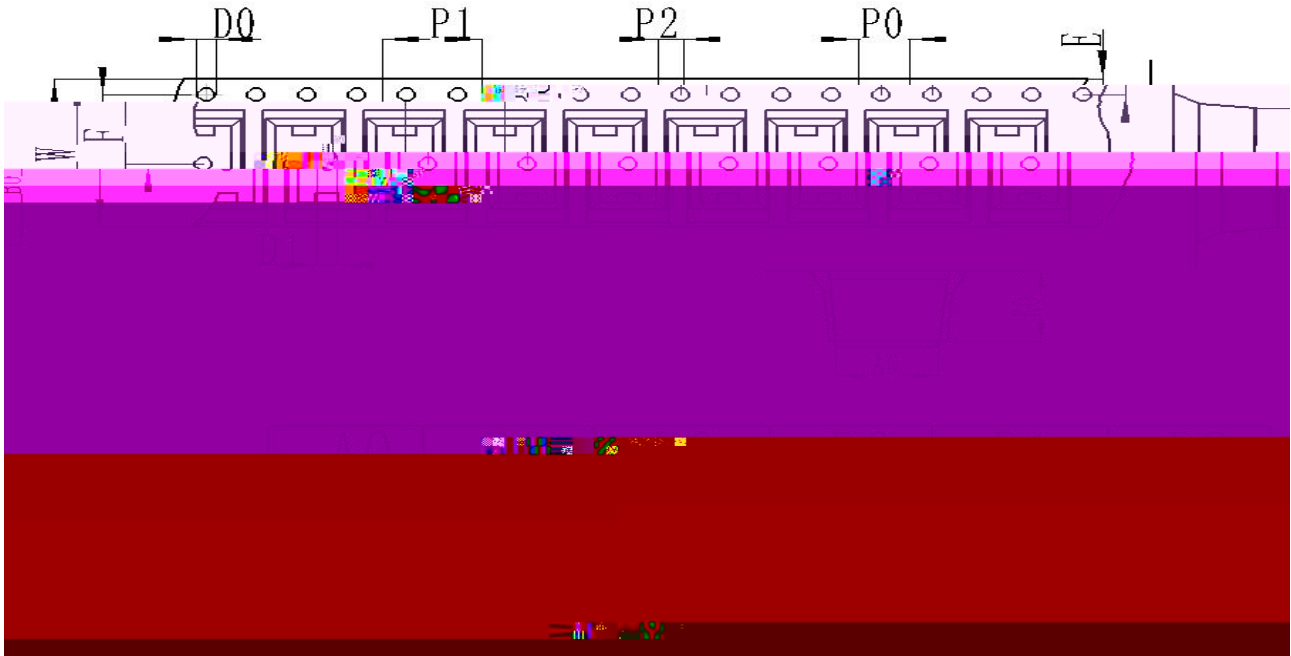

SPEC	W	N	T1	T2	A	D	E	F
	24.4 0.3	Φ100 3.0	2.2 0.3	2.2 0.3	Φ380 3.0	13.3 0.3	2.3 0.5	10.75 0.5

Carton Packing

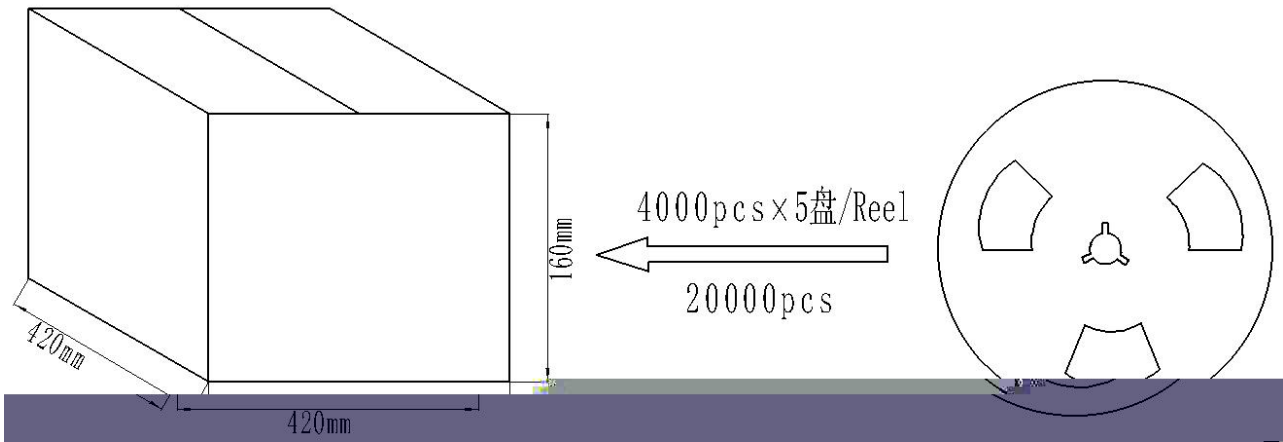

☆ 回流焊接曲线



☆



FILE NO.	QC-T4-09
Ver:	1.0
Page	19/21

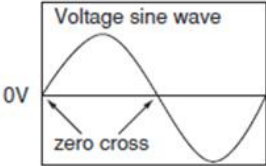
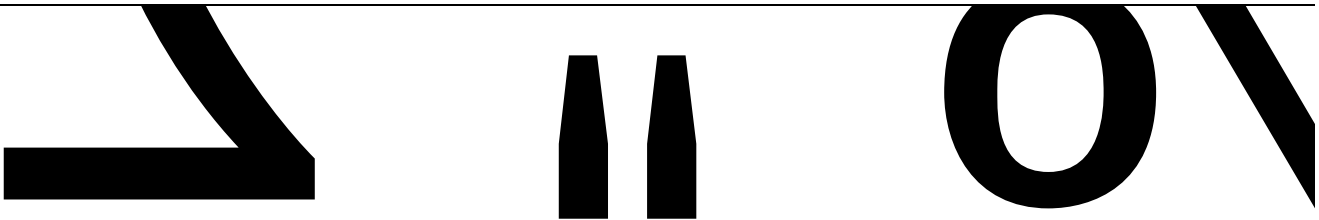



	FILE NO.	QC-T4-09
	Ver:	1.0
	Page	20/21



1.

(1)

(2)

2.