一级代理商：

深圳市弗瑞鑫电子有限公司

地址：深圳市宝安区西乡大道302号金源商务大厦B座三楼

frxelec

1.



2.

3.

4.

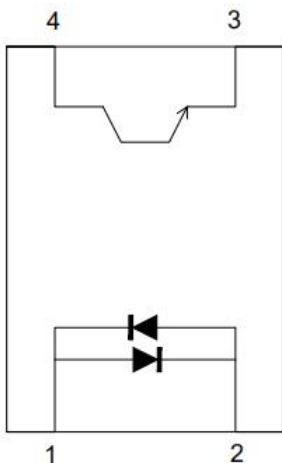

pin No. and Internal connection diagram

- 1 Anode/Cathode
- 2 Anode/Cathode
- 3 Emitter
- 4 Collector

5.



6.

7.

8.

9.

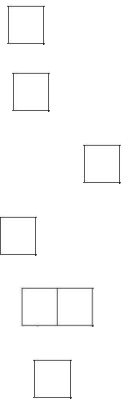
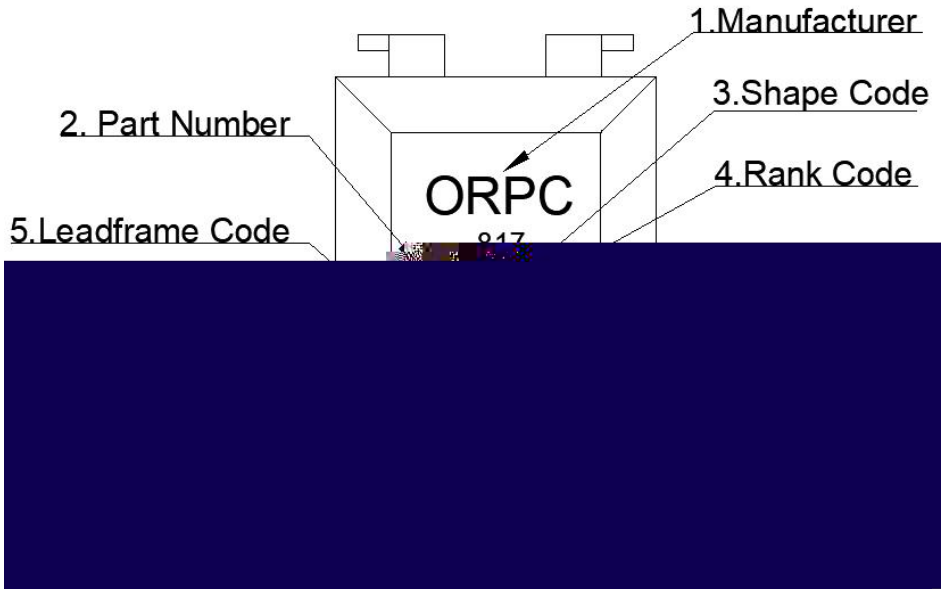

10.

1.

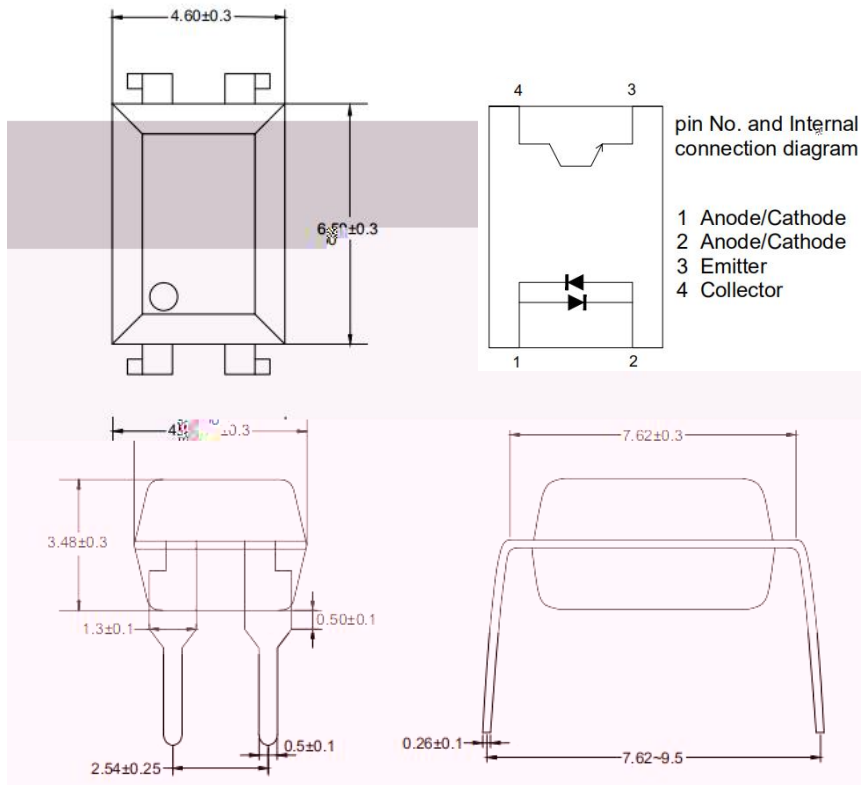

2.

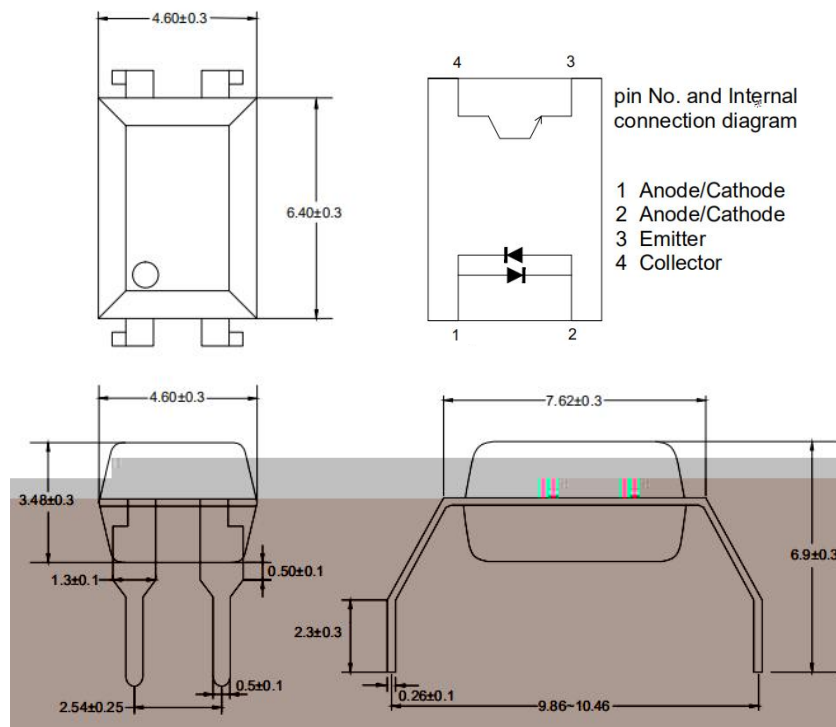

3.

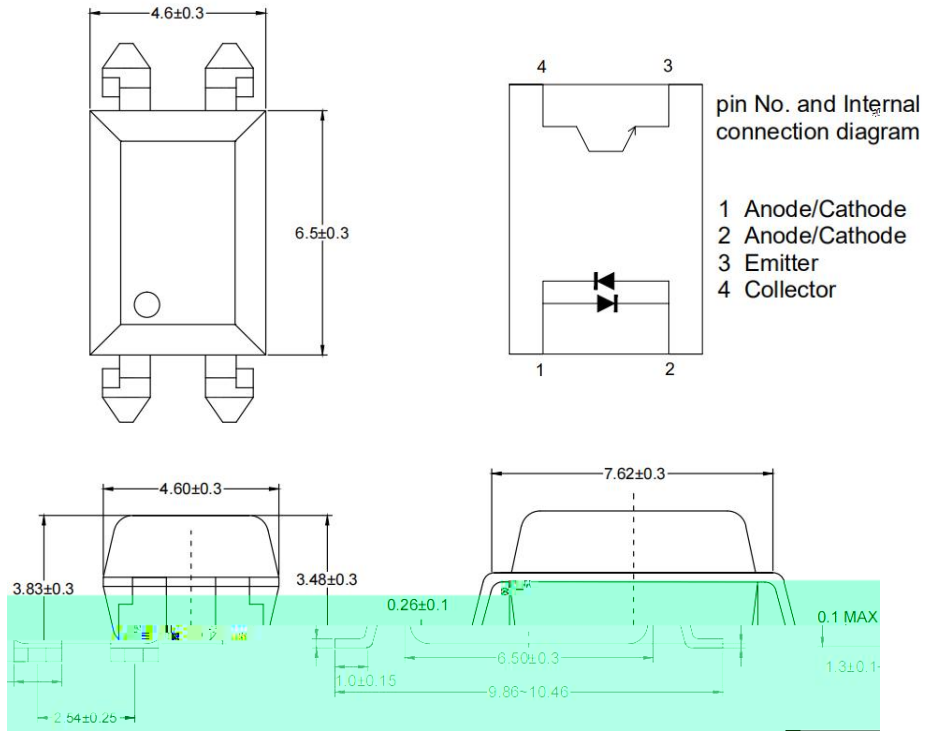

11.

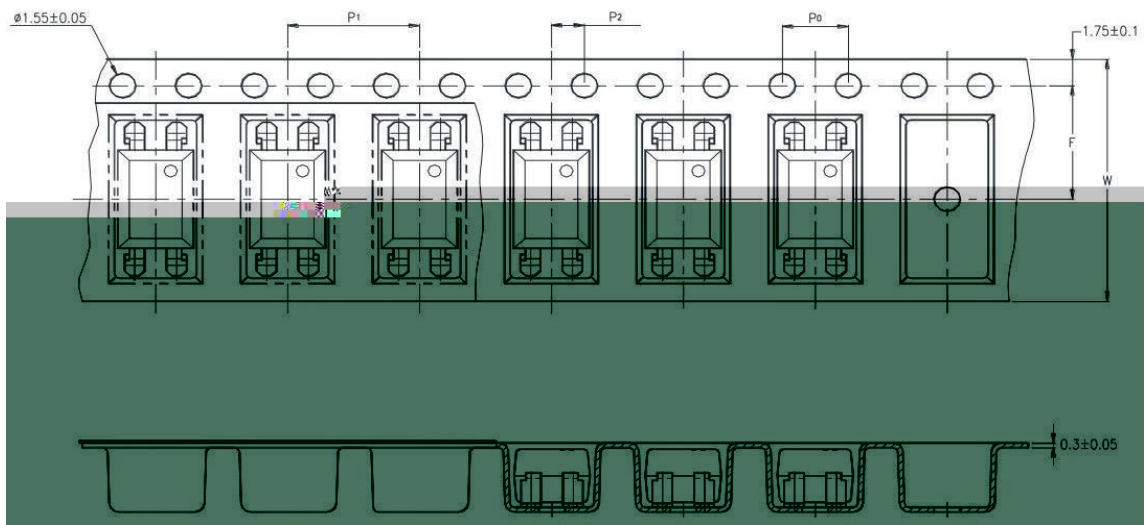



12.

14.

1	22	22- 106
2	77	22- 103
3	77	22- 11
4	77	

15.

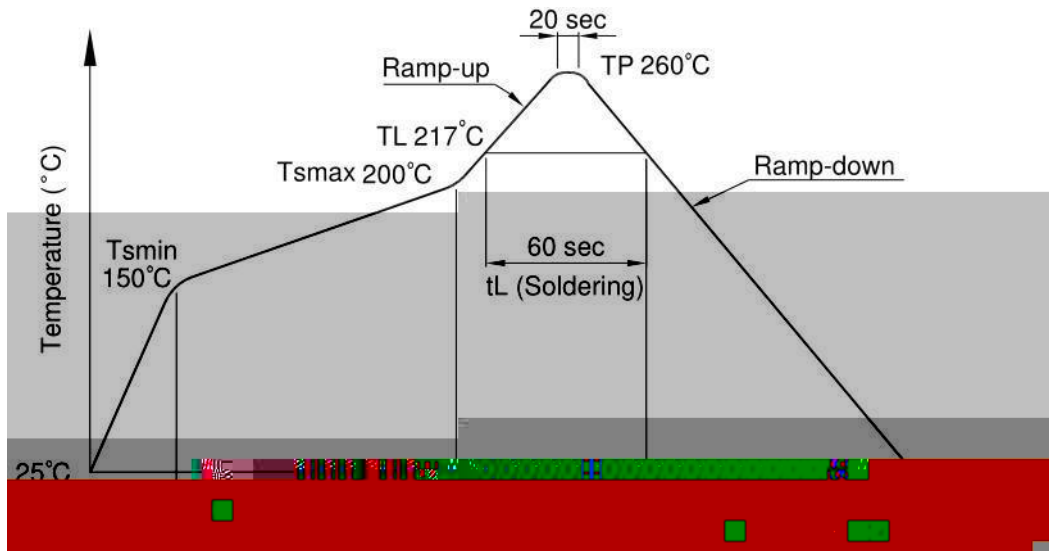

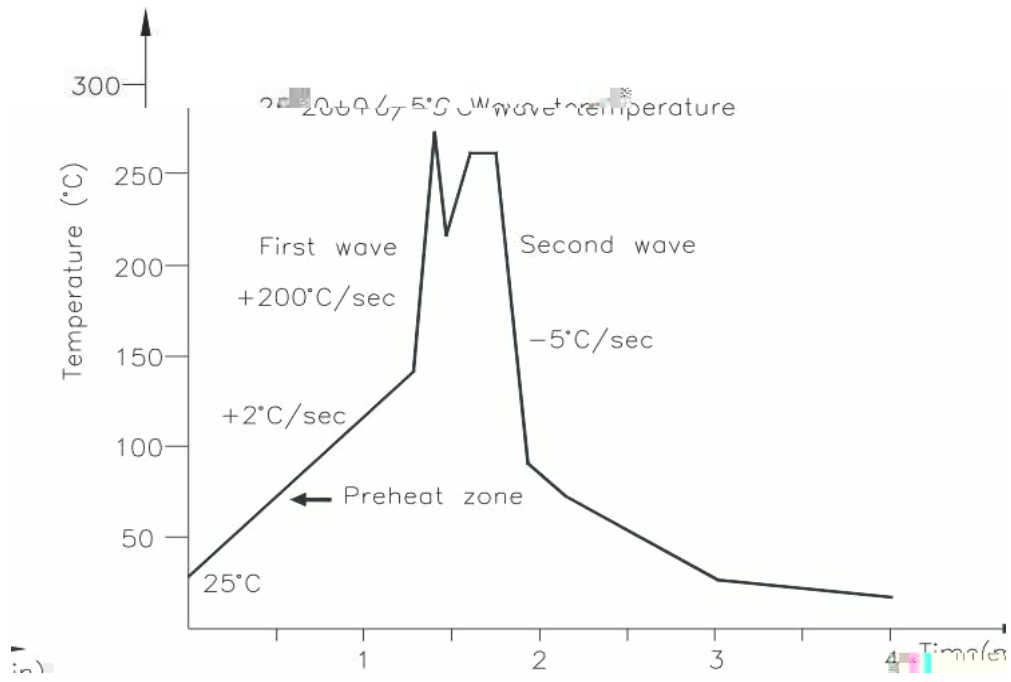

--	--

16.

Fig.1 Forward current vs Ambient temperature

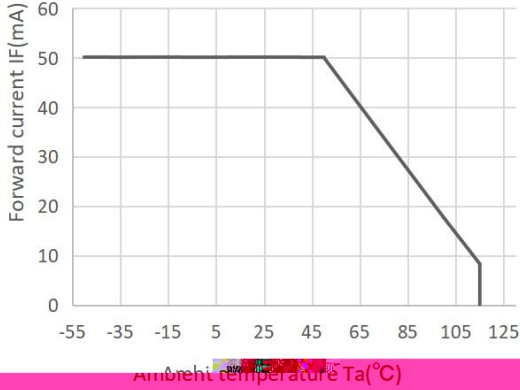

Fig.2 Collector Power Dissipation vs. Ambient temperature

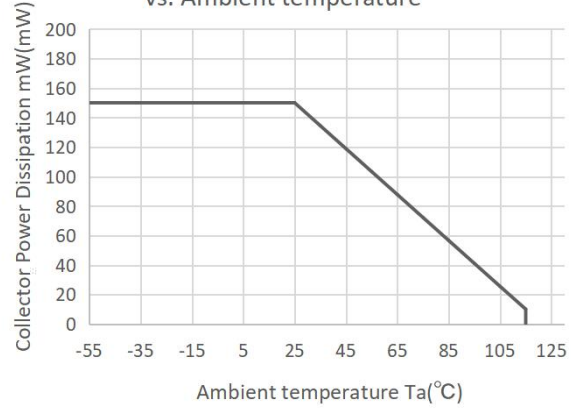

Fig.3 Collector-emitter Saturation Voltage vs. Forward Current

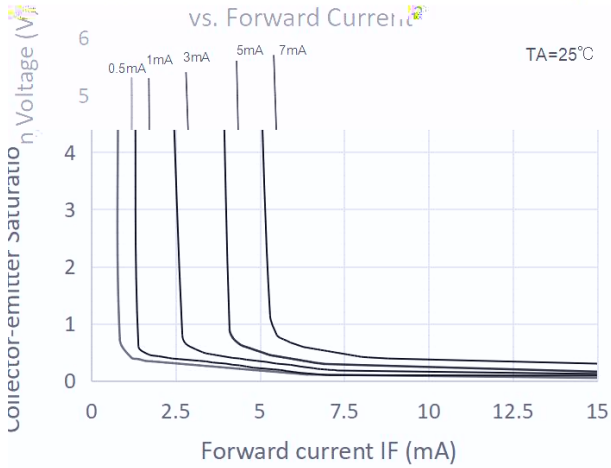

Fig.4 Forward Current vs. Forward Voltage

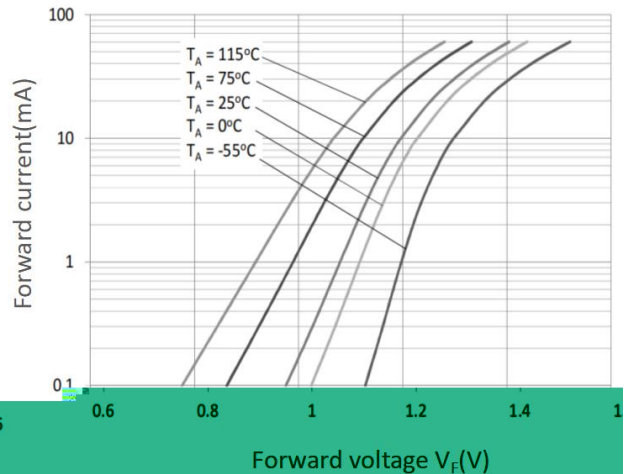

Fig.5 Forward Current vs. Current Transfer Ratio

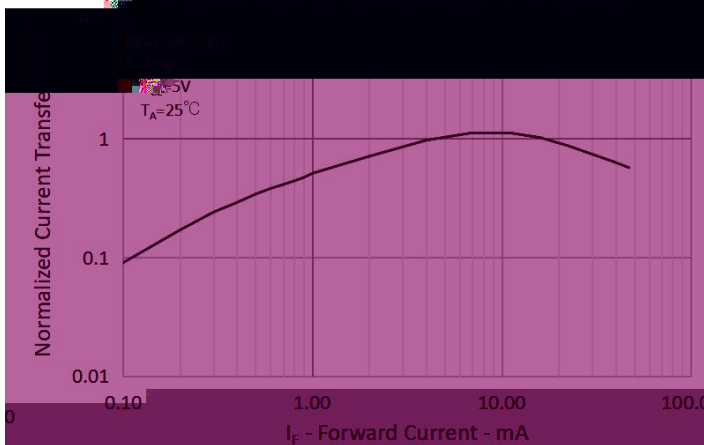

Fig.6 Collector Current vs. Collector-emitter Voltage

