

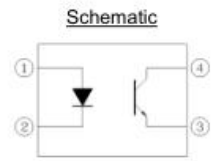

-10

---

1.

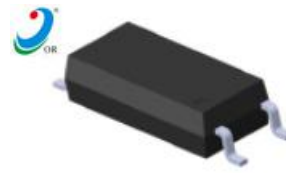

Pin Configuration

- 1. Anode
- 2. Cathode
- 3. Emitter
- 4. Collector





2.  
3.

-10

4-

( 2 )

Parameter	Symbol	Rated Value	Unit
		60	
		125	
		6	
		100	
		0	
		7	
		50	
		150	
		250	
*1		5000	
		-55 + 110	
		-55 + 125	
*2		260	

\*1 1 , . . . 40 60% . . . , 1, 2 , 3, 4 .

\* 2 10



2

Parameter		Symbol	Condition	Min	Typ.*	Max	Unit
			50	---	1.25	1.6	
			4	---	---	10	
			0, 1	---	50	---	
			20 , 0	---	10	100	
			1 0	0	---	---	
			0.1 0	7	---	---	
			5	50	---	600	%
			5	2.5	---	30	
		( )	10 1	---	---	0.3	
			500 40 60% . . .	10 <sup>12</sup>	---	---	
			0, 1	---	0.3	---	
			5 , 2	---	3	1	
			100	---	4.7	1	



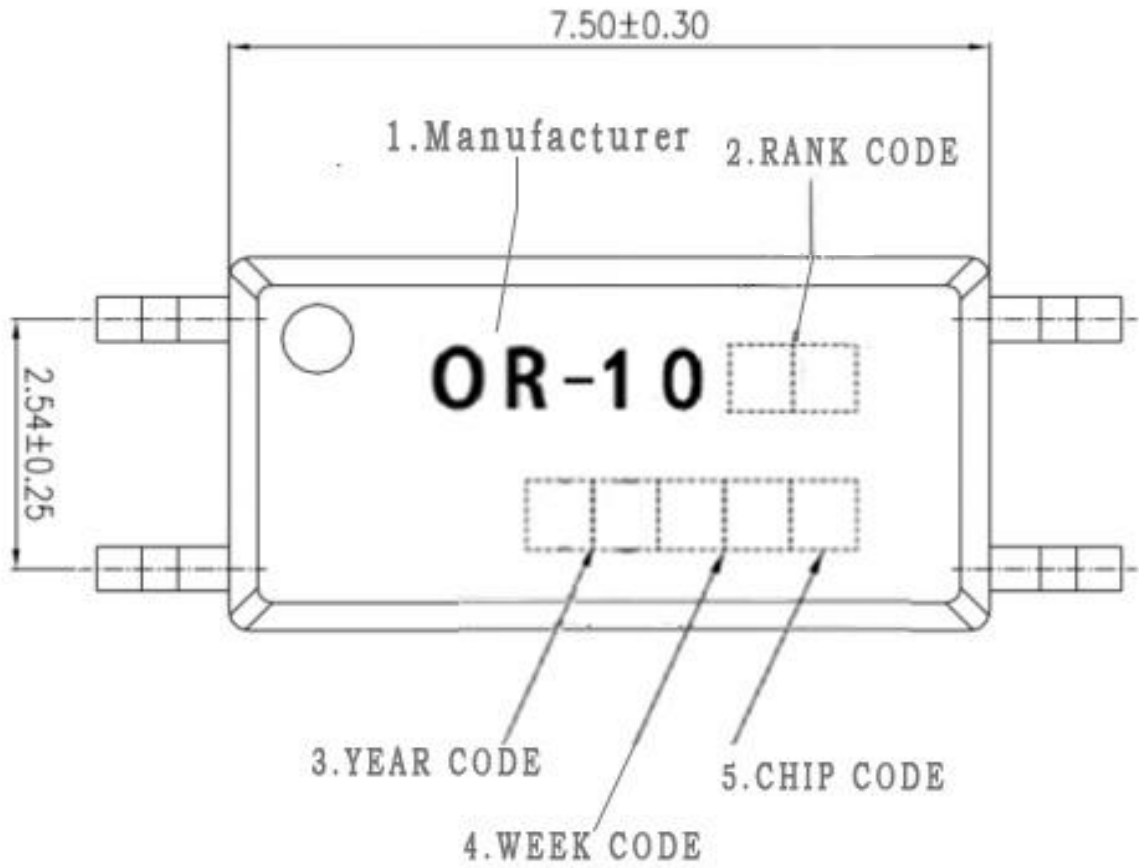

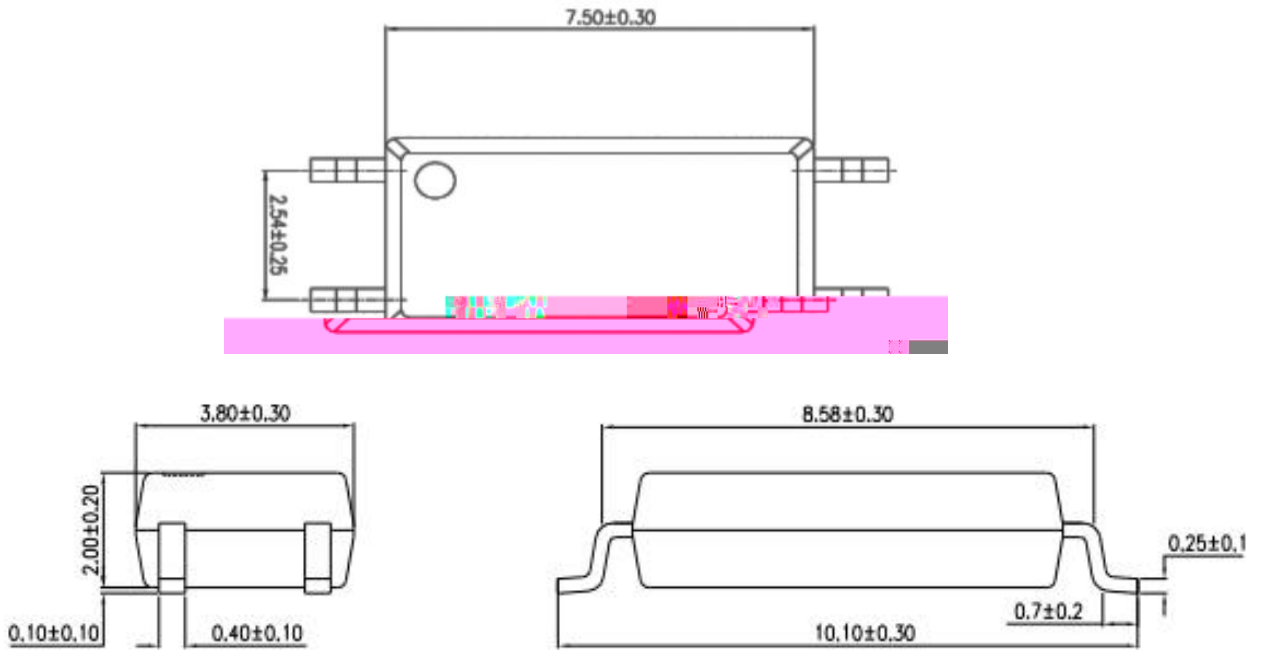

( )

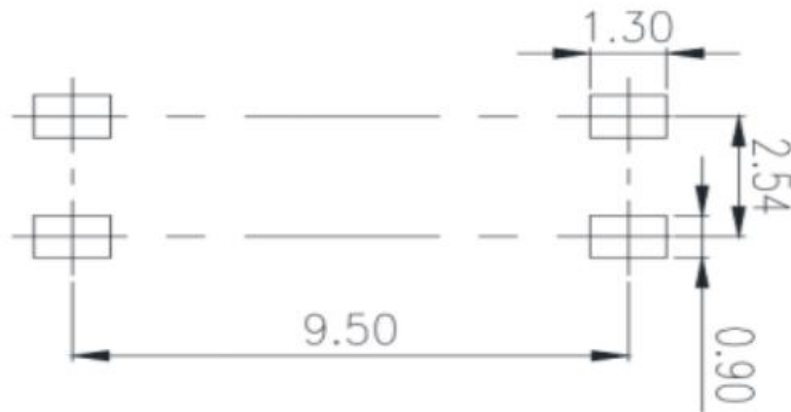

10.

(1) -10 -

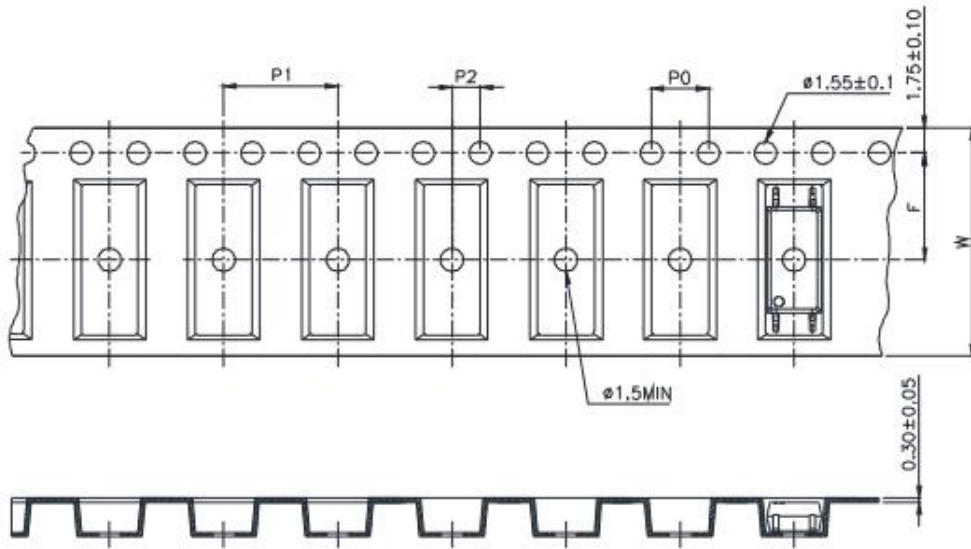

(2) -10 - 1

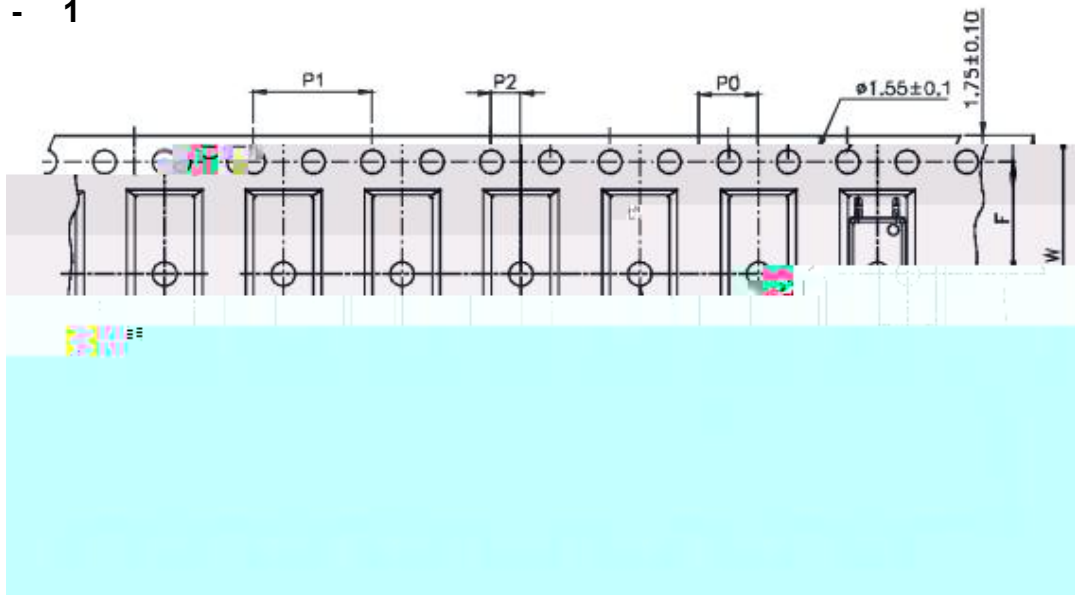



11.

(1). ( -020 )

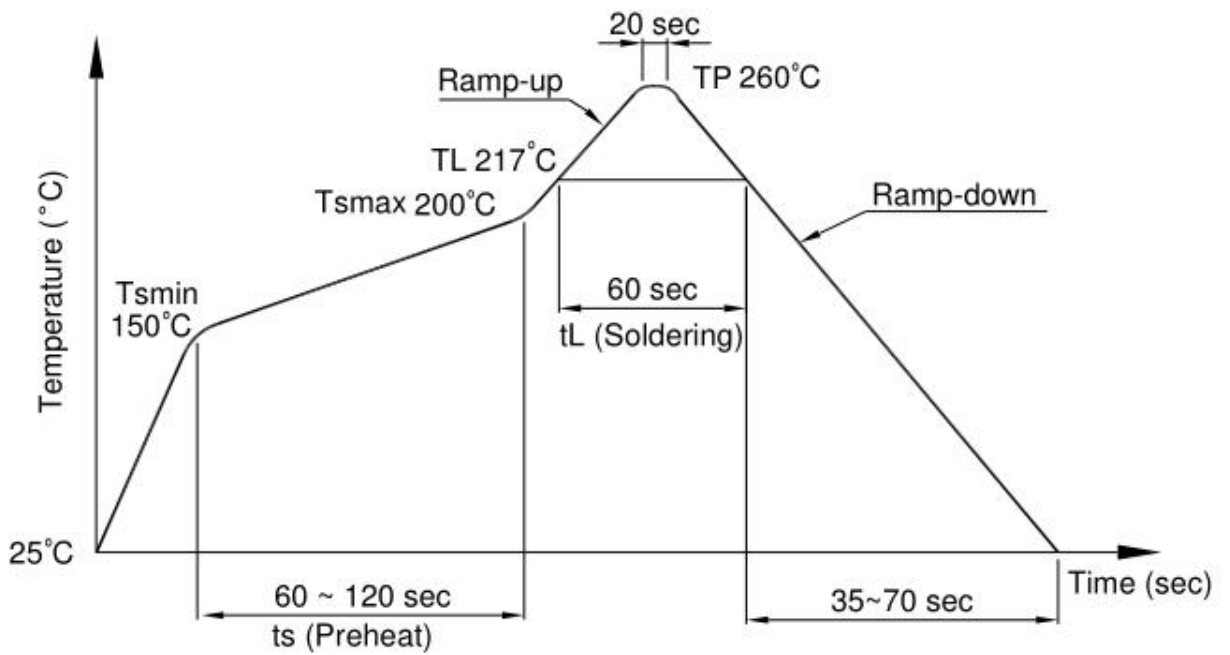



12.

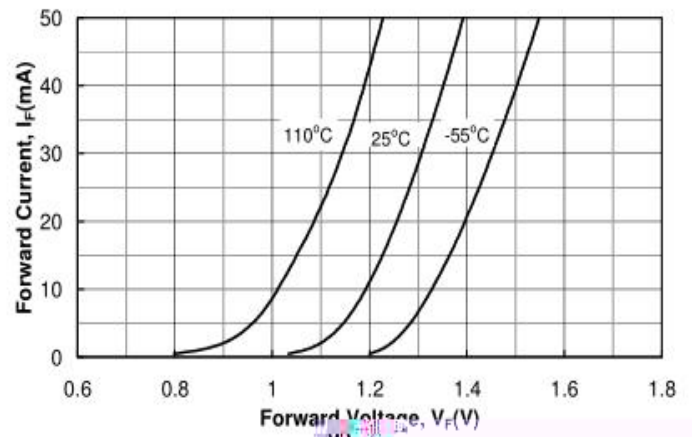
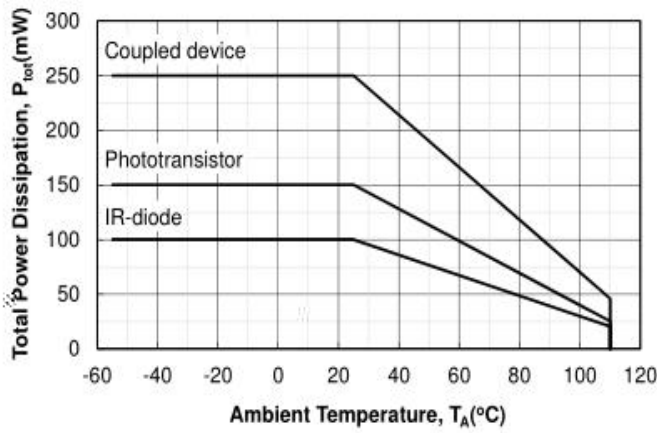
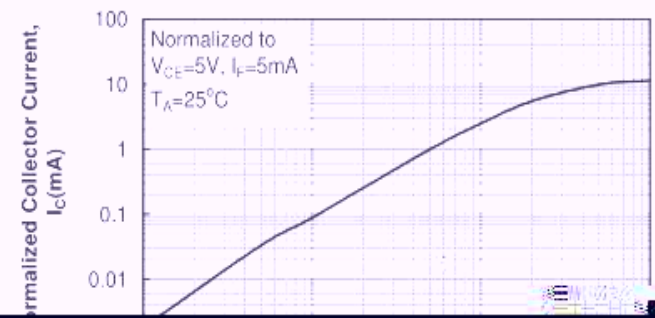
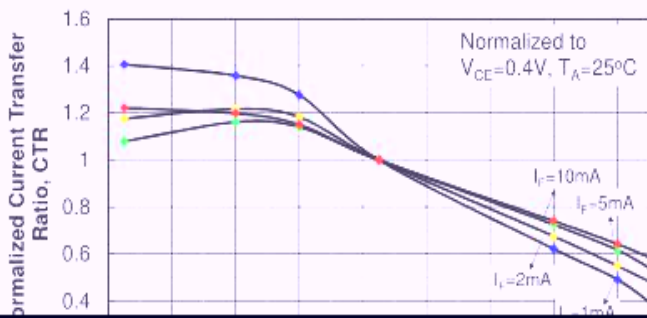

Figure 1.  $P_{tot}$  vs.  $T_A$

Figure 4.  $I_F$  vs.  $V_F$



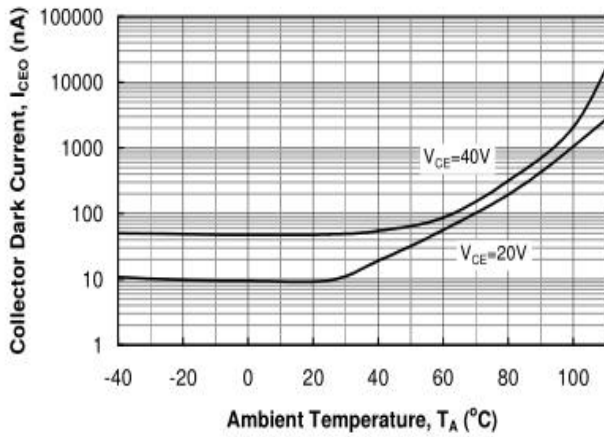

Figure 7.  $I_{CEO}$  vs.  $T_A$

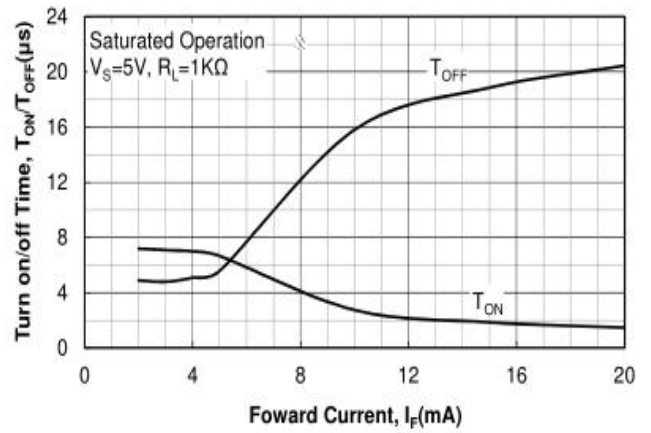

Figure 10.  $T_{ON} / T_{OFF}$  vs.  $I_F$

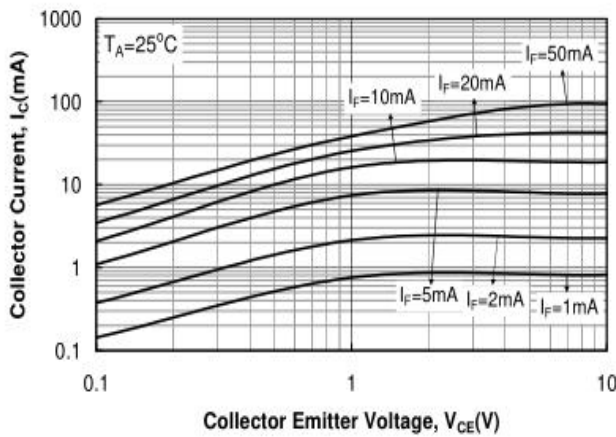

Figure 8.  $I_C$  vs.  $V_{CE}$

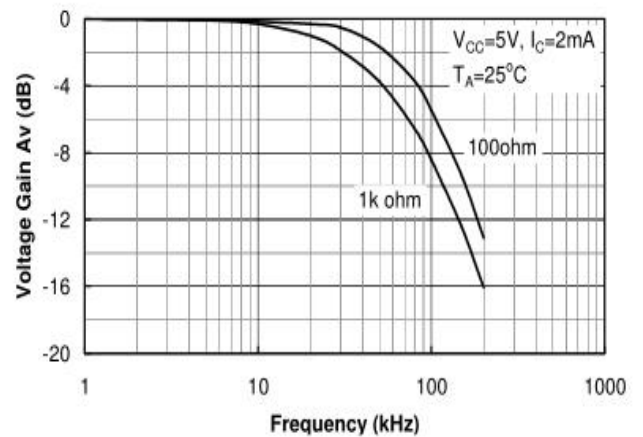

Figure 11. Frequency Response

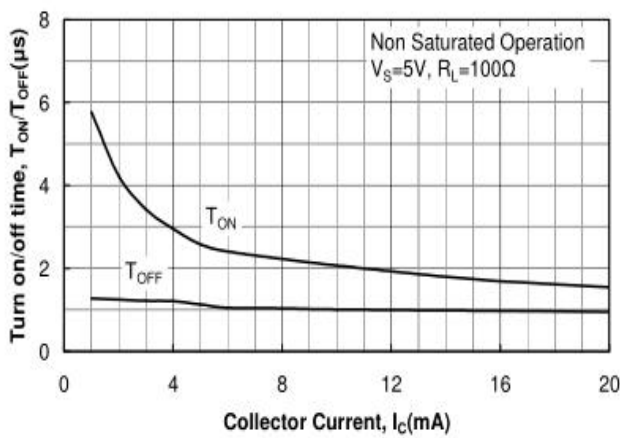

Figure 9.  $T_{ON} / T_{OFF}$  vs.  $I_C$

