

规格承认书

—

prepare	
check	
approve	



TRX电容一级代理商

深圳市弗瑞鑫电子有限公司

Add: 深圳市宝安区西乡大道302号金源商务大厦B座3楼

Tel: 0755-29563634

Fax: 0755-27447020

 TRX 专注电容器廿年	SMD Y SMD Y1 a.c. ceramic capacitors			
	/Number		/Date	
	/Edition		/Page	

 <p>TRX 专注电容器廿年</p>	SMD Y SMD Y1 a.c. ceramic capacitors		
	/Number		/Date
	/Edition		/Page

1. /Product Name



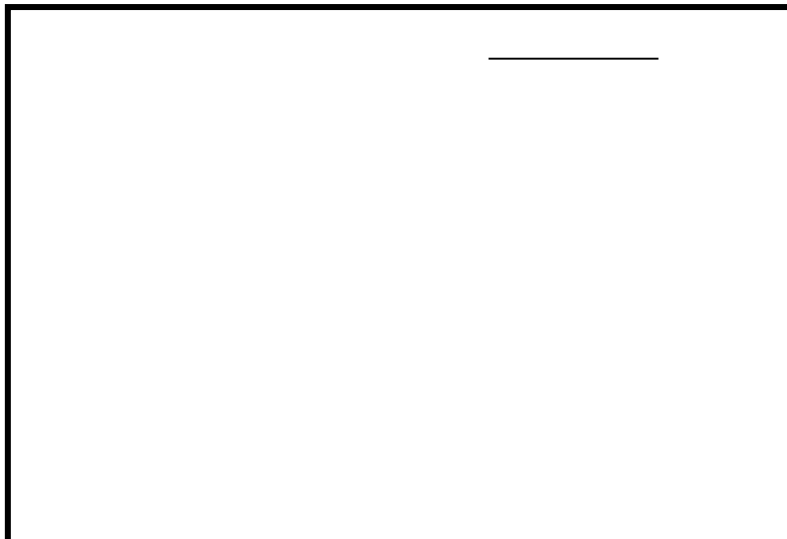
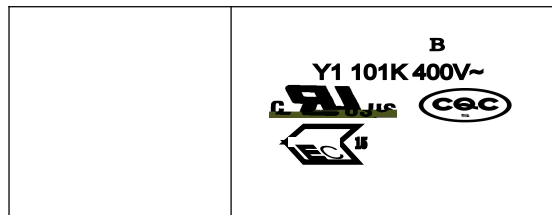

T M Y1 101 K
 ① ② ③ ④ ⑤

①		
②		
③		
④		
⑤		

2. /Product marking



 <p>TRX 专注电容器廿年</p>	SMD Y SMD Y1 a.c. ceramic capacitors		
	/Number		/Date
	/Edition		/Page

/Explanation	
	
	
	
	
	

3. /Date code

↓	↓				
		↓	↓		

4. /Certificates

certificates			

5. / Product structure

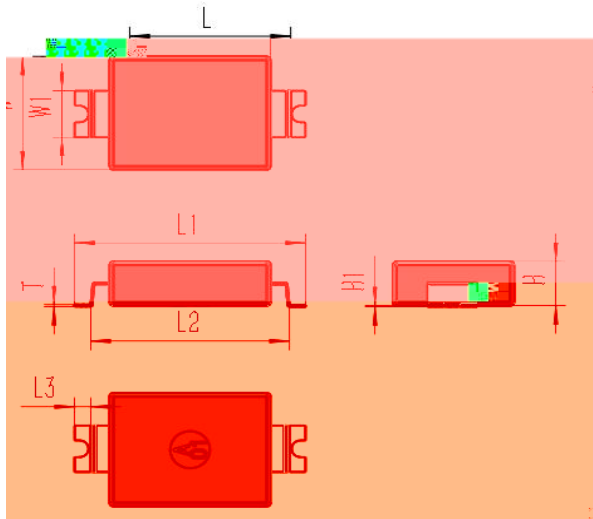

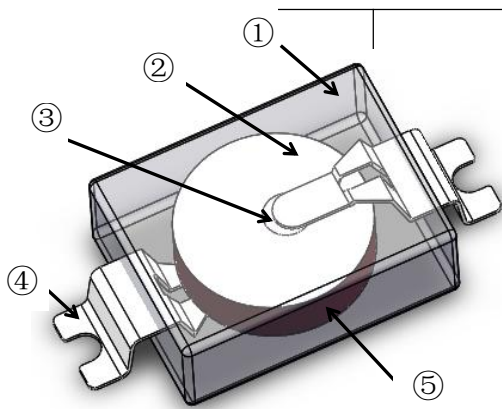

(4)		
(5)		

/Number		/Date	
/Edition		/Page	

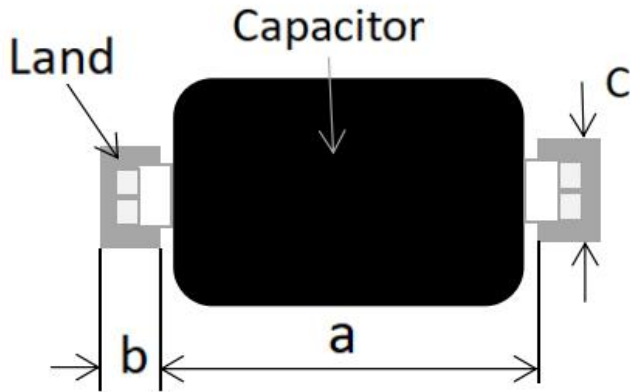

6. / Soldering condition

/

°
°C
°
°

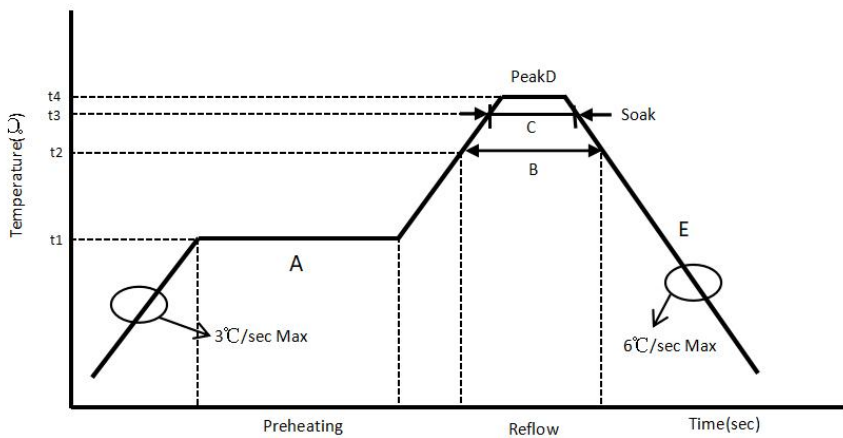

	SMD Y SMD Y1 a.c. ceramic capacitors		
	/Number		/Date
	/Edition		/Page

/

°
°C

°

°

°

/

7. / Performance and test methods

 TRX 专注电容器廿年	SMD Y SMD Y1 a.c. ceramic capacitors			
	/Number		/Date	
	/Edition		/Page	





SMD Y
SMD Y1 a.c. ceramic capacitors

/Number

/Date

/Edition

/Page

			△ △ △ △ △
			△ △ △ △ △

8. /Capacitor temperature characteristic

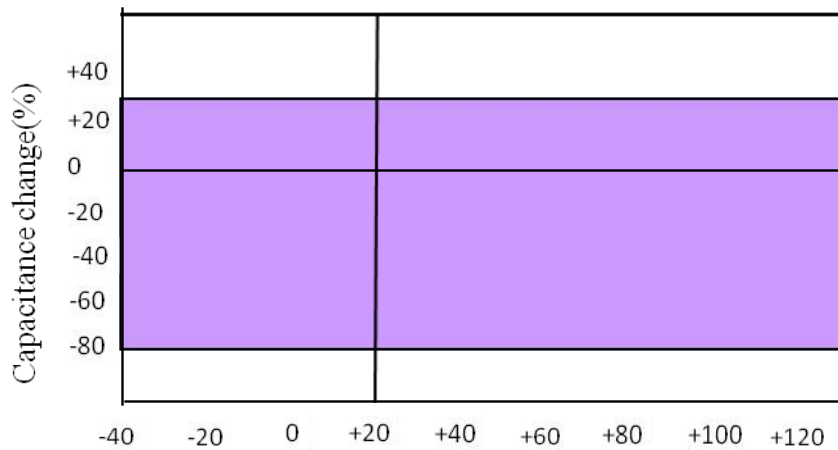

 TRX 专注电容器廿年	SMD Y		
	SMD Y1 a.c. ceramic capacitors		
	/Number		/Date
	/Edition		/Page

11. /Product Packing

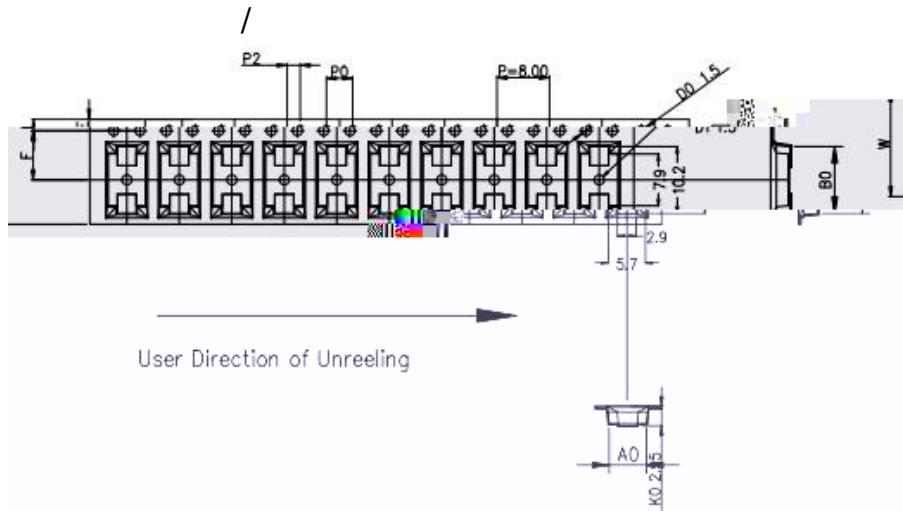

ITEM	Δ W	A0	B0	K1	K0	P	F	E	D0	D1	P0	P2	T
DIM	16.0 +0.30 -0.10	5.70 +0.10 -0.10	10.20 +0.10 -0.10	---	2.95 +0.10 -0.10	8.00 +0.10 -0.10	7.50 +0.10 -0.10	1.75 +0.18 -0.08	1.5 +0.10 -0.05	4.0 +0.10 -0.10	2.0 +0.10 -0.10	0.30	
ALTERNATE													

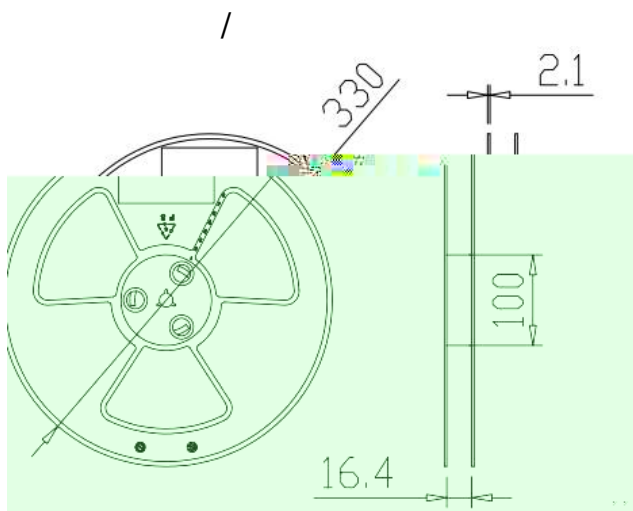

Item	Data	Remark
Cover tape adhesion	10 ~ 100g	Carrier tape and cover tape open angle 165 ~ 180° F=300±5mm/minute

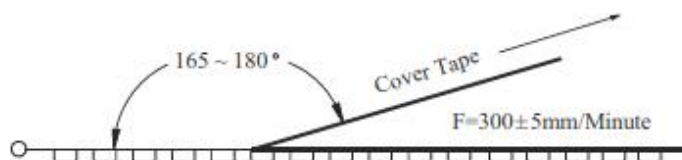

 TRX 专注电容器廿年	SMD Y SMD Y1 a.c. ceramic capacitors		
	/Number		/Date
	/Edition		/Page

/inner-packaging

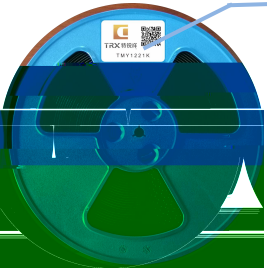

标签



料号

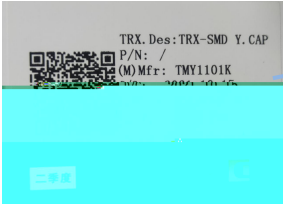

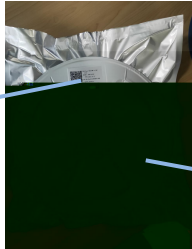

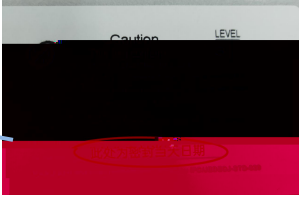

/Outer-packaging

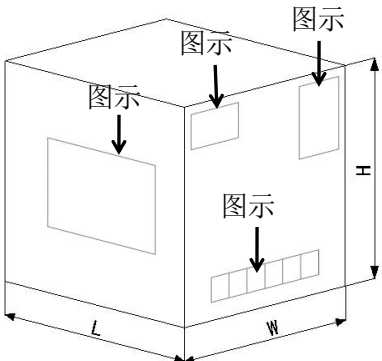



图示 /



图示 /



图示 /

/Package sketch:



/



/





Remark

	SMD Y SMD Y1 a.c. ceramic capacitors			
	/Number		/Date	
	/Edition		/Page	

12. /Application notes

①

②

③

④

⑤

⑥