

Fea e :

A lica i :

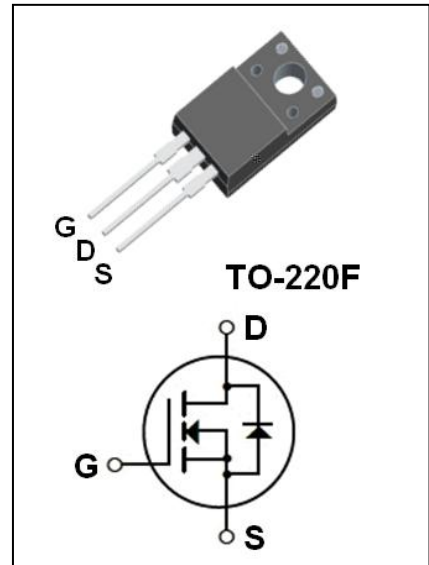

Ab l e Ma im m Ra i g °

		°	
		°	
		±	
		°)	
			°
			°
			°

*

The mal Cha ac e i ic

			°
			°

Electrical Characteristics

Off Characteristics						
△		○				○
△		○				
On Characteristics						
Dynamic Characteristics						
Switching Characteristics						
Thermal Resistance and Maximum Ratings						

、
、
、
、
、
、

○ ○
○

O -Regi Cha ac e i ic

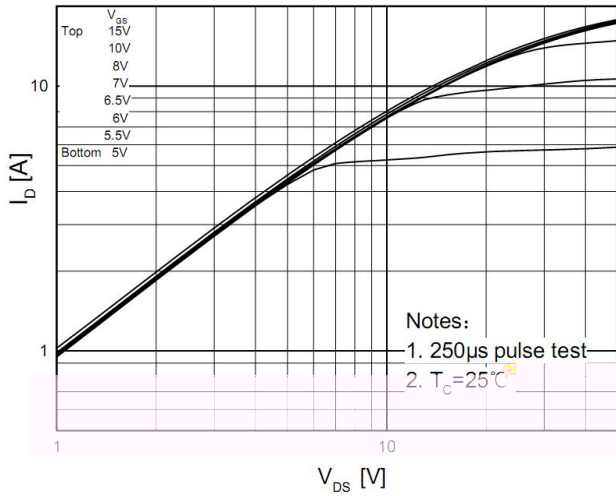

T a fe Cha ac e i ic

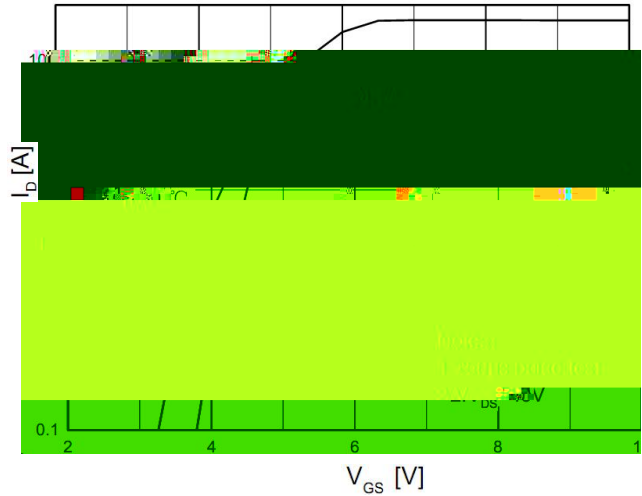

**O -Re i a ce Va ia i .
D ai C e a d Ga e V I age**

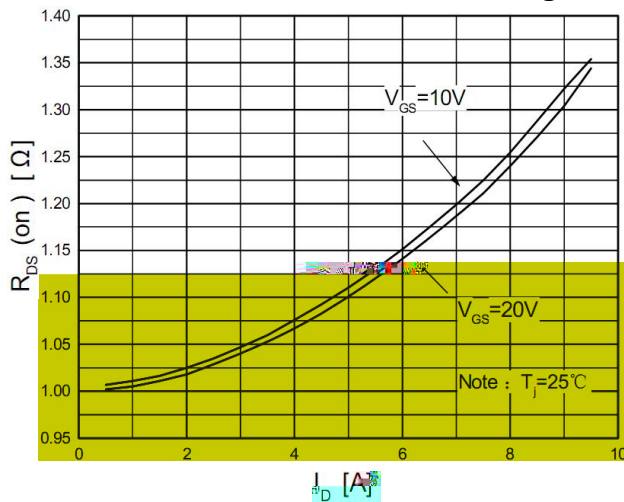

**B d Di de F a d V I age Va ia i .
. S ce C e a d Tem e a e**

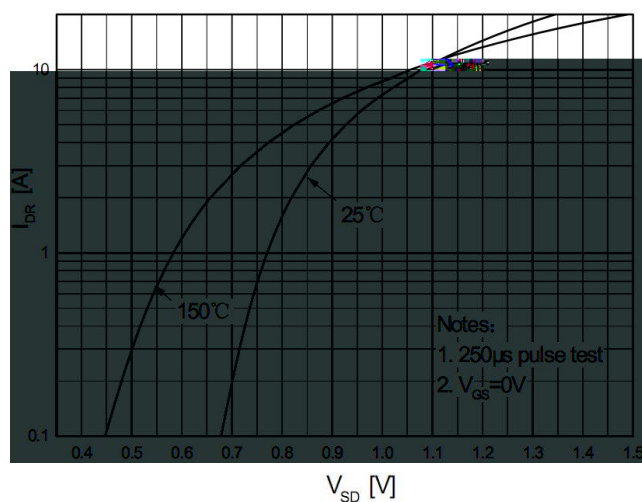

Ca aci a ce Cha ac e i ic

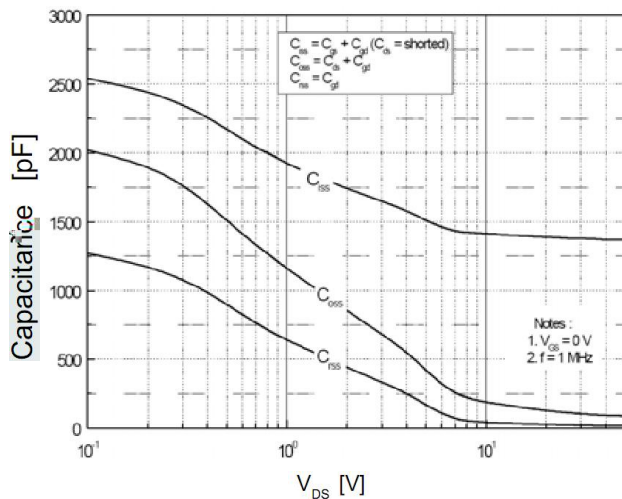

Ga e Cha ge Cha ac e i ic

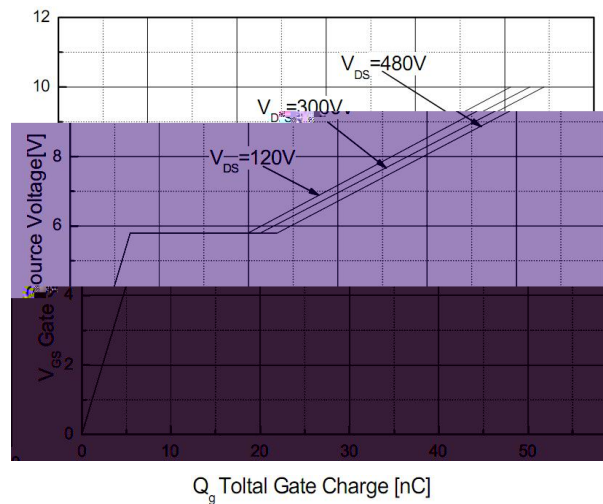

Breakdown Voltage Variation with Temperature

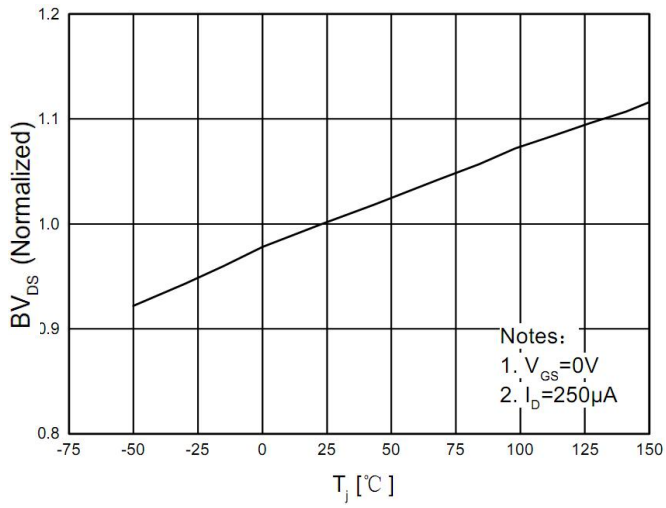

On-Resistance Variation with Temperature

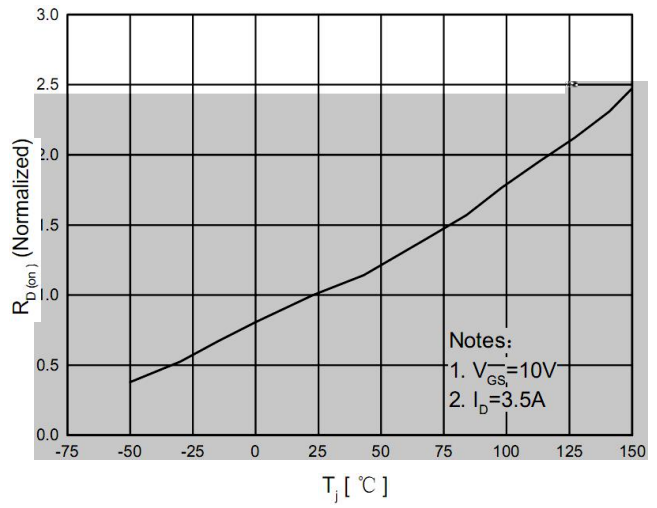

Maximum Safe Operating Area

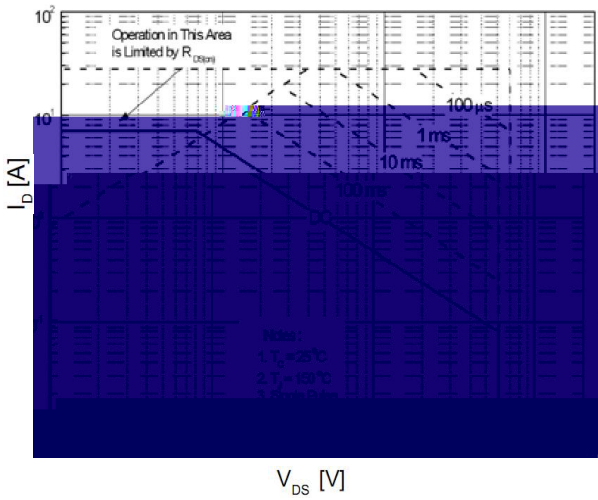

Maximum Drain Current vs Temperature

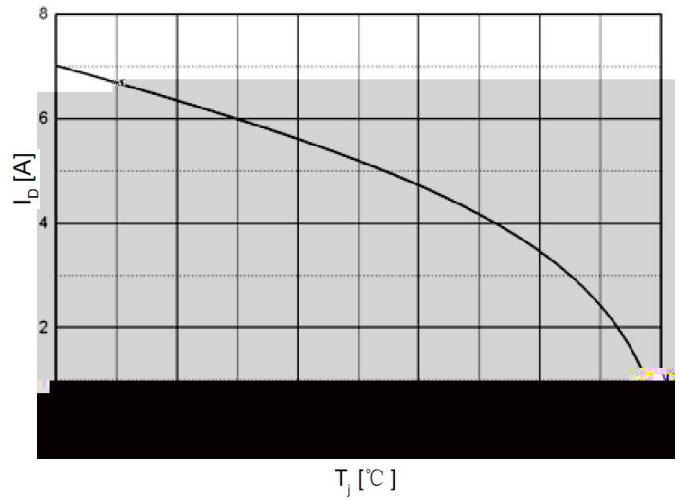

TO-220F Package Dimension

:

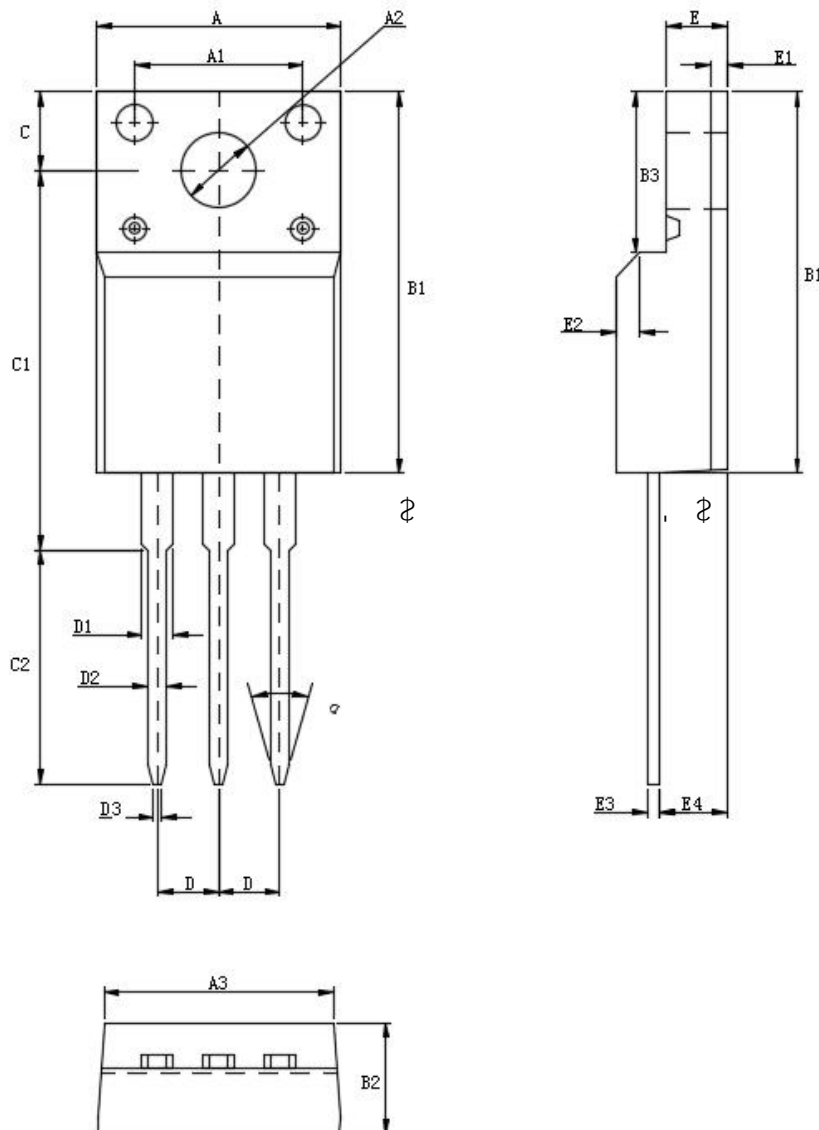

× °
°

∅