



## IGBT Modules

$V_{CES}$	1200V
$I_c$	300A

### Applications

- Inverter for motor drive
- AC and DC servo drive amplifier
- UPS (Uninterruptible Power Supplies)
- Soft switching welding machine

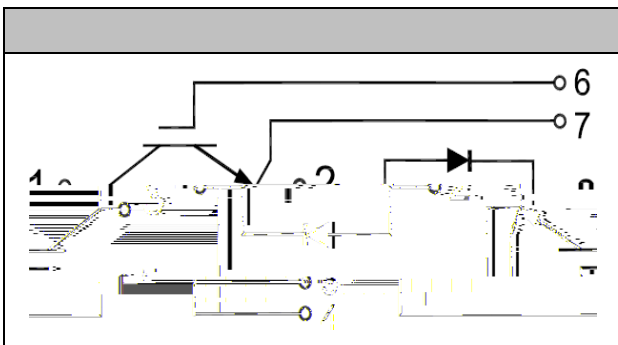

### Features

- Low  $V_{ce(sat)}$  with Trench technology
- $V_{ce(sat)}$  with positive temperature coefficient
- High short circuit capability(10us)
- Including ultra fast & soft recovery anti-parallel FWD
- Low inductance
- Maximum junction temperature 175

## ● IGBT

### Absolute Maximum Ratings

Parameter	Symbol	Conditions	Value	Unit
Collector-Emitter Voltage	$V_{CES}$	$V_{GE}=0V, I_c = 1mA, T_{vj}=25$	1200	V
Continuous Collector Current	$I_c$	$T_c=100$	300	A
Repetitive Peak Collector Current	$I_{CRM}$	$t_p=1ms$	600	A
Gate-Emitter Voltage	$V_{GES}$	$T_{vj}=25$	20	V
Total Power Dissipation	$P_{tot}$	$T_c=25$ $T_{vjmax}=175$	1700	W

**Characteristic values**

Parameter	Symbol	Conditions	Value			Unit
			Min.	Typ.	Max.	
Gate-emitter Threshold Voltage	$V_{GE(th)}$	$V_{GE}=V_{CE}, I_C=8mA, T_{vj}=25$	5.2	5.8	6.4	V
Collector-Emitter Cut-off Current	$I_{CES}$	$V_{CE}=1200V, V_{GE}=0V, T_{vj}=25^{\circ}C$			1.0	mA
Collector-Emitter Saturation Voltage	$V_{CE(sat)}$	$I_C=300A, V_{GE}=15V, T_{vj}=25$		1.85	2.20	V
		$I_C=300A, V_{GE}=15V, T_{vj}=125$		2.20		
		$I_C=300A, V_{GE}=15V, T_{vj}=150$		2.30		
Gate Charge	$Q_G$			2.6		uC
Internal Gate Resistor	$R_{Gint}$			2.5		
Input Capacitance	$C_{ies}$	$V_{CE}=25V, V_{GE}=0V,$		18.4		nF
Reverse Transfer Capacitance	$C_{res}$	$f=1MHz, T_{vj}=25^{\circ}C$		0.9		nF
Gate-Emitter leakage current	$I_{GES}$	$V_{CE}=0V, V_{GE}=20V, T_{vj}=25$			400	nA
Turn-on Delay Time	$t_{d(on)}$	$I_C=300A$ $V_{CE}=600V$ $V_{GE}=\pm 15V$ $R_G=1.8\Omega$ $T_{vj}=25$		174		ns
Rise Time	$t_r$			38		ns
Turn-off Delay Time	$t_{d(off)}$			425		ns
Fall Time	$t_f$			104		ns
Energy Dissipation During Turn-on Time	$E_{on}$			17.4		mJ
Energy Dissipation During Turn-off Time	$E_{off}$			21.0		mJ
Turn-on Delay Time	$t_{d(on)}$	$I_C=300A$ $V_{CE}=600V$ $V_{GE}=\pm 15V$ $R_G=1.8\Omega$ $T_{vj}=125$		185		ns
Rise Time	$t_r$			42		ns
Turn-off Delay Time	$t_{d(off)}$			495		ns
Fall Time	$t_f$			170		ns
Energy Dissipation During Turn-on Time	$E_{on}$			26.5		mJ
Energy Dissipation During Turn-off Time	$E_{off}$			31.4		mJ
Turn-on Delay Time	$t_{d(on)}$	$I_C=300A$ $V_{CE}=600V$ $V_{GE}=\pm 15V$ $R_G=1.8\Omega$ $T_{vj}=150$		191		ns
Rise Time	$t_r$			45		ns
Turn-off Delay Time	$t_{d(off)}$			437		ns
Fall Time	$t_f$			112		ns
Energy Dissipation During Turn-on Time	$E_{on}$			29.3		mJ
Energy Dissipation During Turn-off Time	$E_{off}$			33.5		mJ
SC Data	$I_{sc}$	$T_p \leq 10\mu s, V_{GE}=15V,$ $T_{vj}=150, V_{cc}=900V,$ $V_{CEM} \leq 1200V$		1500		A



## Diode

### Absolute Maximum Ratings

	Symbol	Conditions	Value	Unit
Repetitive Peak Reverse Voltage	$V_{RRM}$	$T_{vj}=25$	1200	V
Continuous DC Forward Current	$I_F$		300	A
Repetitive Peak Forward Current	$I_{FRM}$	$t_p=1ms$	600	A
$I^2t$ -value	$I^2t$	$V_R=0, t_p=10ms, T_j=125$	18200	A <sup>2</sup> s
		$V_R=0, t_p=10ms, T_j=150$	17000	

### Characteristic values

Parameter	Symbol	Conditions	Value			Unit
			Min.	Typ.	Max.	
Forward Voltage	$V_F$	$I_F=300A, T_{vj}=25$		2.10		V
		$I_F=300A, T_{vj}=125$		2.15		
		$I_F=300A, T_{vj}=150$		2.17		
Recovered Charge	$Q_{rr}$	$I_F=300A$		34.0		uC
Peak Reverse Recovery Current	$I_{rr}$	$V_R=600V$ $-di_F/dt=6500A/us$ $T_{vj}=25$		375		A



## ● Module Characteristics

$T_C=25^{\circ}\text{C}$  unless otherwise specified

Parameter	Symbol	Conditions	Value			Unit
			Min.	Typ.	Max.	
Isolation voltage	$V_{\text{isol}}$	$t=1\text{min}, f=50\text{Hz}$	2500			V
Maximum Junction Temperature	$T_{\text{jmax}}$				175	
Operating Junction Temperature	$T_{\text{vjop}}$		-40		150	
Storage Temperature	$T_{\text{stg}}$		-40		125	
Thermal Resistance Junction-to Case	$R_{\text{JC}}$	per IGBT				K/W
		per Diode				
Thermal Resistance Case-to Sink	$R_{\text{CS}}$	Conductive grease applied		0.035		K/W
Comparative Tracking Index	CTI			>400		
Module Electrodes Torque	$M_t$	Recommended(M6)	3.0		5.0	N·m
Module-to-Sink Torque	$M_s$	Recommended(M6)	3.0		5.0	N·m
Weight of Module	G			315		g

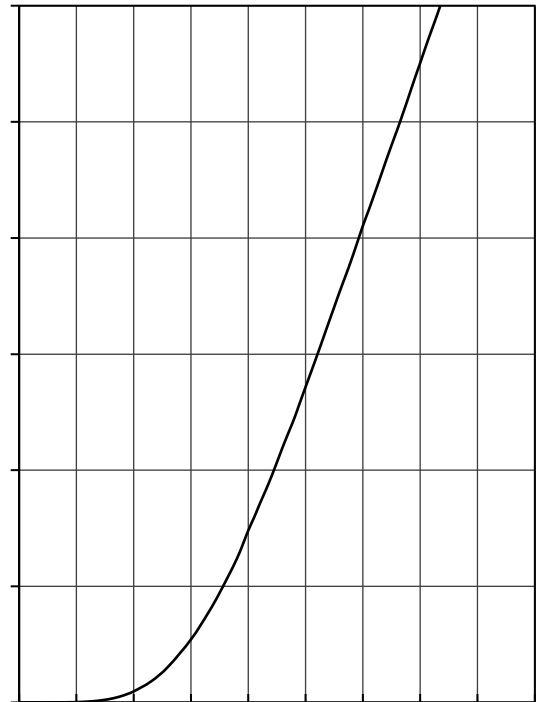
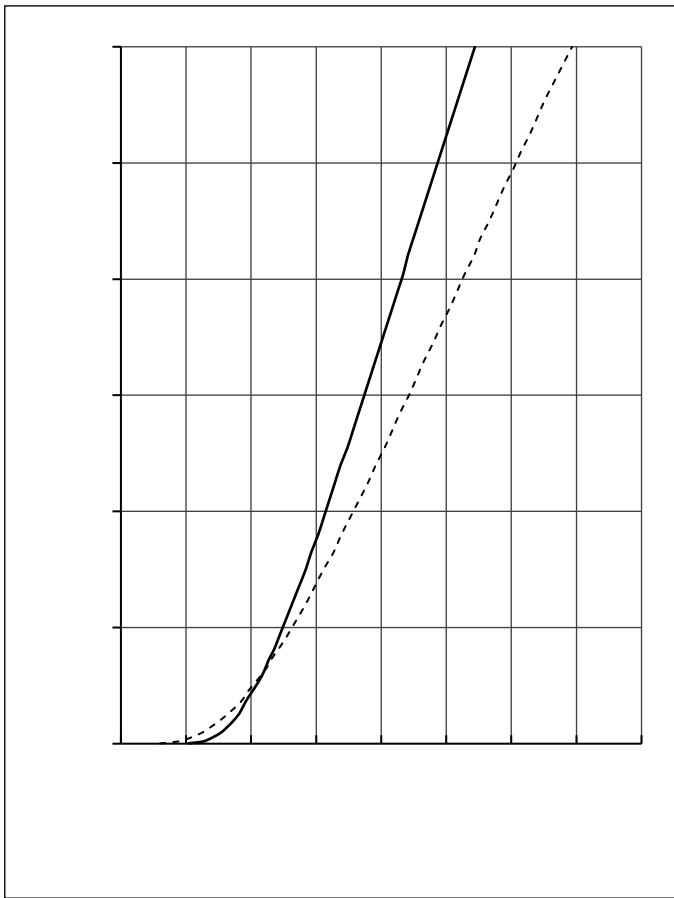

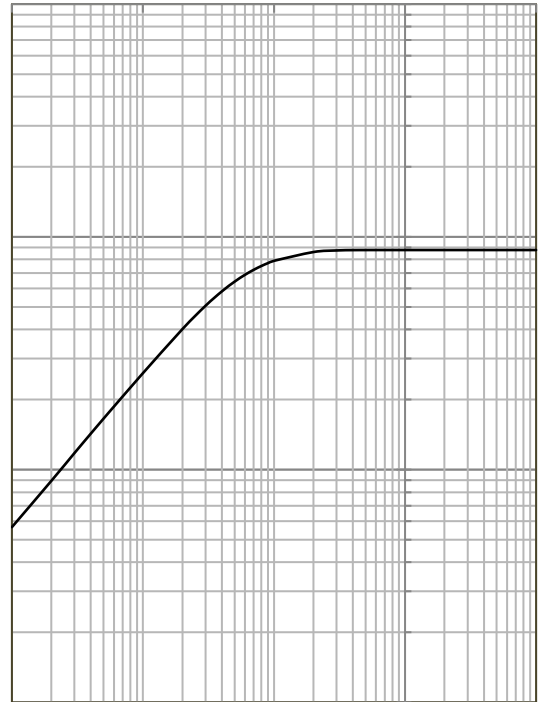
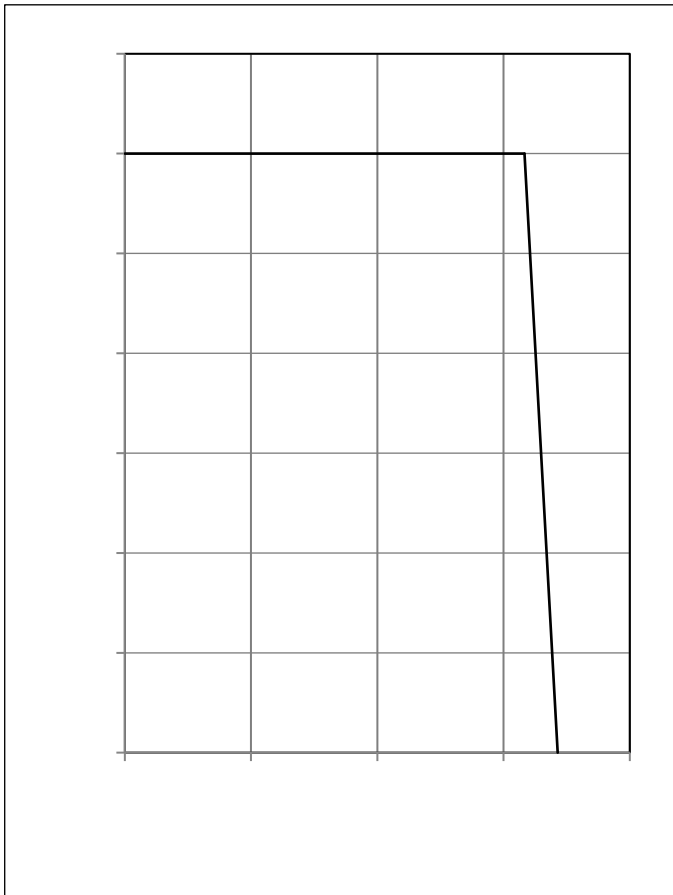

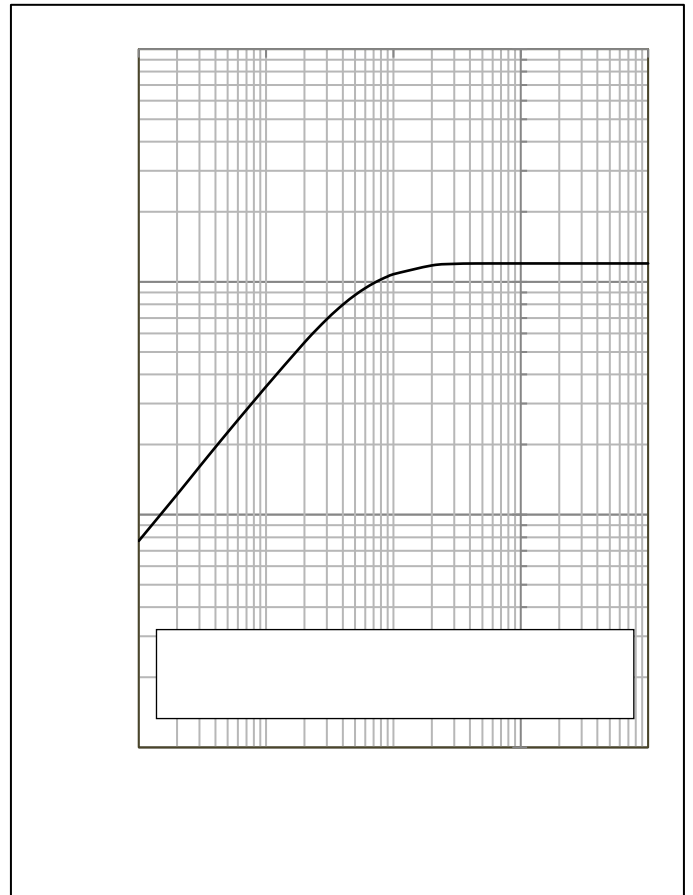
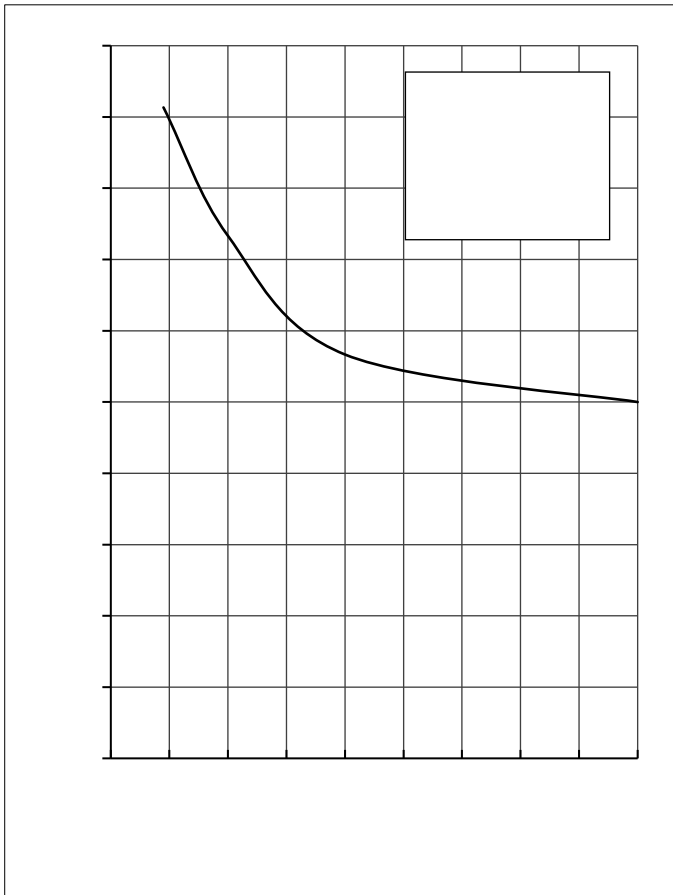

● Circuit Diagram

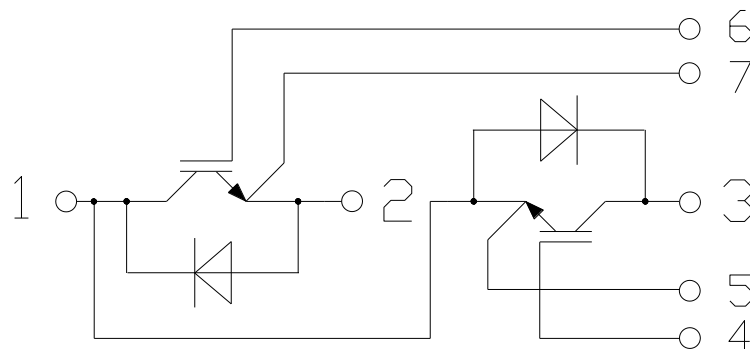

● Dimensions in Millimeters

