

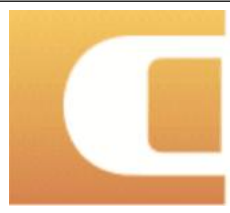

TRX 特锐祥
专注电容器廿年

 TRX 专注电容器廿年	SMD- 1			
	SMD 1 . .			
	/N		/D	
/E		/P		

/ I

/ II

TR SMD- 1.CAP

C R T.C D (U : F

T.C						

	SMD- 1 SMD 1 . .		
	/N		/D
	/E		/P

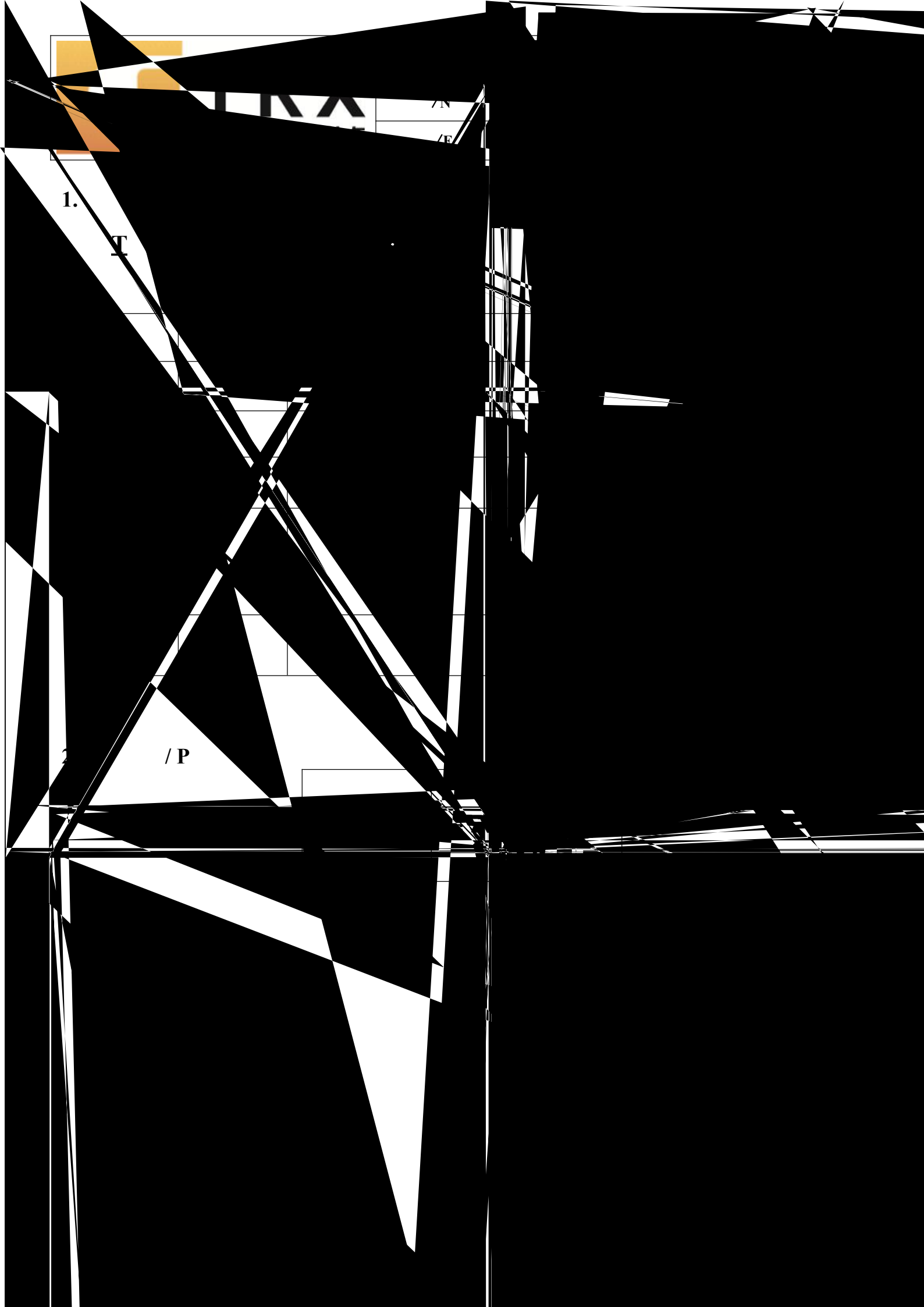

S
C

1.

T

2.

P

7N

4E



SMD- 1
SMD 1 . .

/N

L!

 TRX 专注电容器廿年	SMD- 1		
	SMD 1 . .		
	/N		/D
/E		/P	

/

/

7. /P

	SMD- 1 SMD 1 . .		
	/N		/D
	/E		/P

						<table border="1" style="width: 100%; border-collapse: collapse;"> <tr> <td style="width: 20px;"></td><td style="width: 20px;"></td><td style="width: 20px;"></td><td style="width: 20px;"></td><td style="width: 20px;"></td><td style="width: 20px;"></td></tr> <tr> <td></td><td></td><td></td><td></td><td></td><td></td></tr> </table>													
						±													



SMD- 1
SMD 1 . .

/N

/D

/E

/P

±

SMD- 1
SMD 1 . .

/N

/D

/E

/P

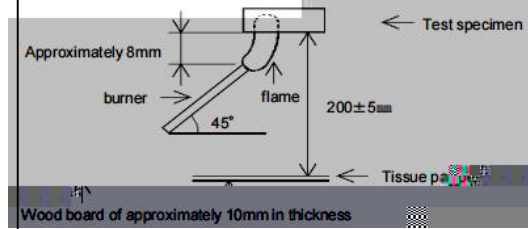

 TRX 专注电容器廿年	SMD- 1		
	SMD 1 . .		
	/N		/D
/E		/P	

			± ±
			± ±
			±
			± ±
			± ±
			±

8. /C

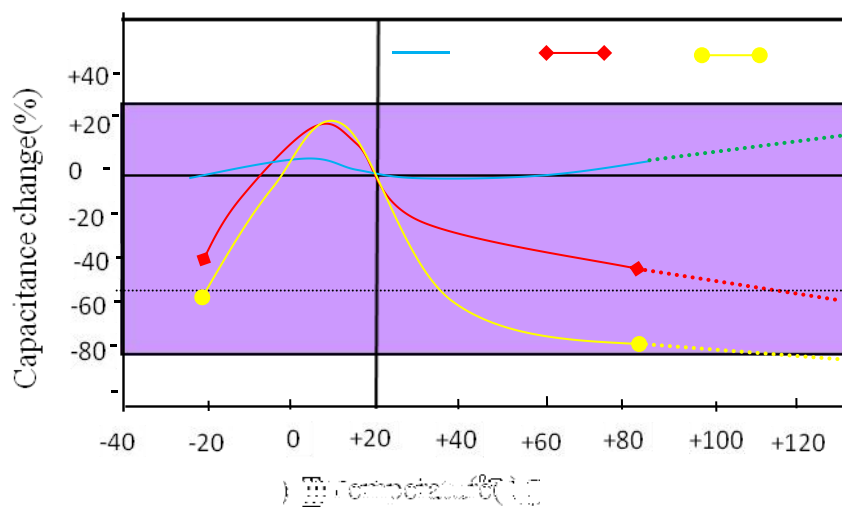

	SMD- 1		
	SMD 1 . .		
	/N		/D
/E		/P	

9.

/C

**R HS H.F.
REACH**

10.

/S

/

/

×

11. /P

/

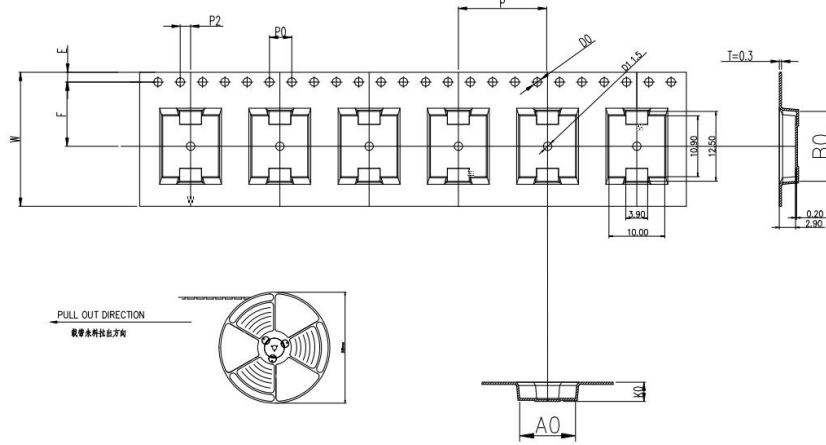

ITEM	W	A0	B0	K1	K0	P	F	E	D0	D1	P0	P2	T											
DIM	24.0	$^{+0.30}_{-0.30}$	10.0	$^{+0.10}_{-0.10}$	12.5	$^{+0.10}_{-0.10}$	3.45	$^{+0.10}_{-0.10}$	16.0	$^{+0.10}_{-0.10}$	11.50	$^{+0.10}_{-0.10}$	1.75	$^{+0.10}_{-0.10}$	10.00	$^{+0.10}_{-0.00}$	1.5	$^{+0.10}_{-0.00}$	4.0	$^{+0.10}_{-0.10}$	2.0	$^{+0.10}_{-0.10}$	0.30	$^{+0.05}_{-0.05}$
ALTERNATE																								

/

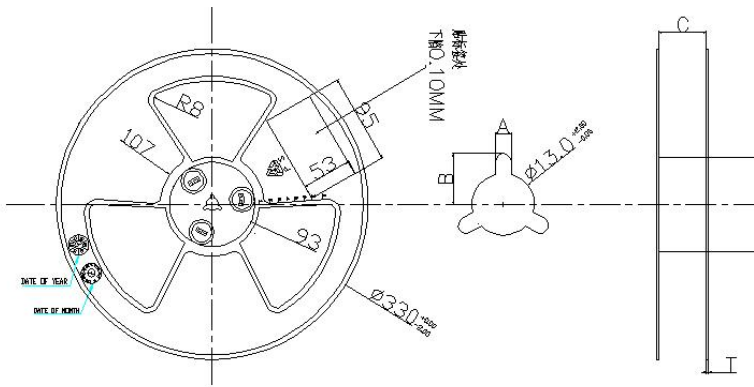

SPEC	A±0.3	B±0.5	C $^{+0.5}_{-0.0}$	D±0.5	T±0.2
24	2.3	10.75	24.4	Ø97	2.2

/

Item	Data	Remark
Cover tape adhesion	10 ~ 100g	Carrier tape and cover tape open angle 165 ~ 180° F=300± 5mm/minute

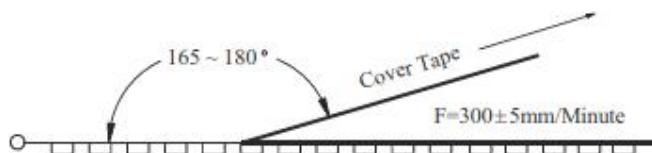

 TRX 专注电容器廿年	SMD- 1 SMD 1 . .		
	/N		/D
	/E		/P

/ -





TRX 特锐祥
TGY1102K







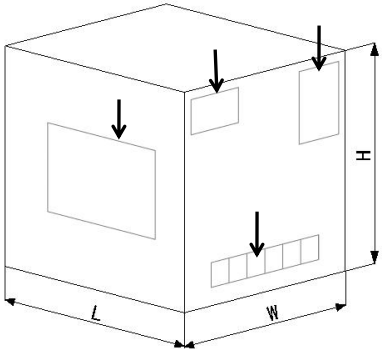

Caution LEVEL
此处为密封当天日期

/O -







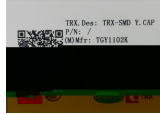





/
/
/

/P :









/
/

" "

R

