



TRX 特锐祥
专 注 电 容 器 廿 年

	SMD- 1		
	SMD 1 . .		
	/N		/D
/E		/P	

/ I

/ II

TR SMD- 1.CAP

C R T.C D (0 : F

T.C						

	SMD- 1 SMD 1 . .		
	/N		/D
	/E		/P



SMD- 1
SMD 1 . .

/N		/D	
/E		/P	

1. /P N

T G 1 102 K

2. /P N



 TRX 专注电容器廿年	SMD- 1		
	SMD 1 . .		
	/N		/D
		/P	

4. /C

5. /P

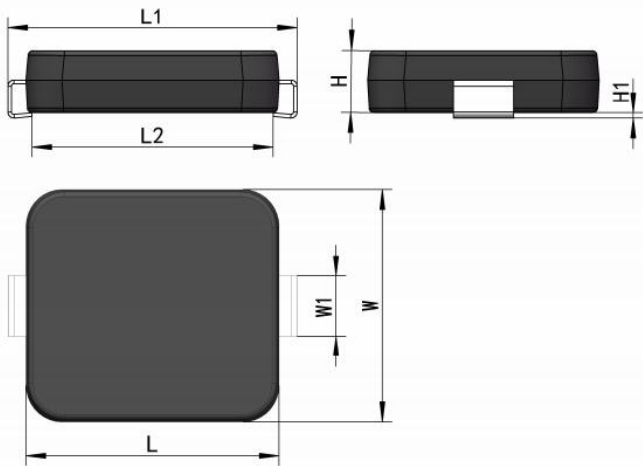

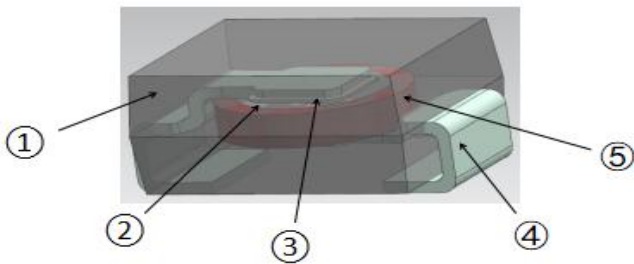



/N

SMD- 1
SMD 1 . .

 TRX 专注电容器廿年	SMD- 1		
	SMD 1 . .		
	/N		/D
/E		/P	

/

/

7. /P



TRX

专注电容器廿年

SMD- 1

SMD 1 . .

/N

/D

/E

/P

				<table border="1" style="width: 100%; border-collapse: collapse; text-align: center;"> <tr> <td style="width: 15%;"></td> <td style="width: 15%;"></td> <td style="width: 15%;"></td> <td style="width: 15%;"></td> <td style="width: 15%;"></td> <td style="width: 15%;"></td> </tr> <tr> <td></td> <td></td> <td></td> <td></td> <td></td> <td></td> </tr> </table>															
				±															



SMD- 1
SMD 1 . .

/N

/D

/E

/P

				±	



SMD- 1
SMD 1 . .

/N

/D

/E

/P

/N

/D

/E

/P

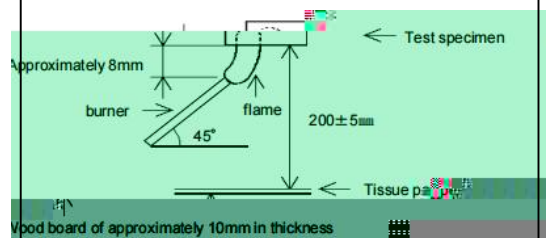

 TRX 专注电容器廿年	SMD- 1		
	SMD 1 . .		
	/N		/D
/E		/P	

			± ±
			± ±
			± ±
			± ±
			± ±
			± ±
			± ±
			± ±
			± ±

8. /C

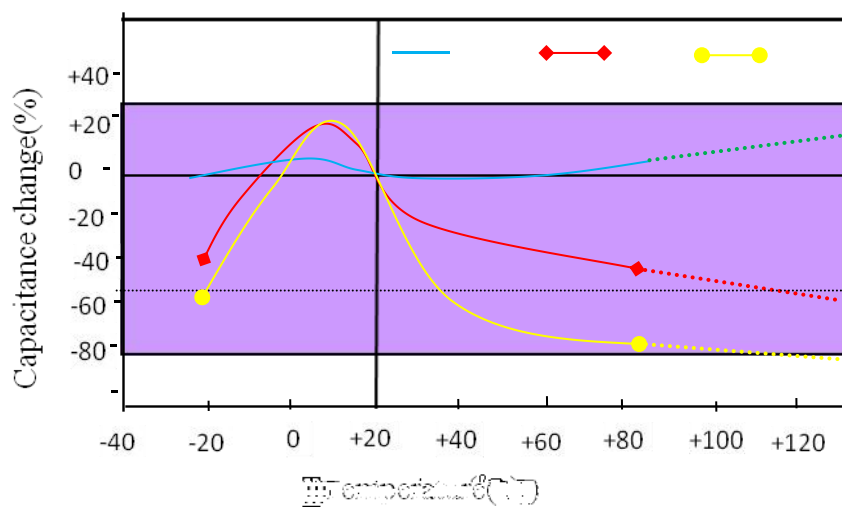

 TRX 专注电容器廿年	SMD- 1		
	SMD 1 . .		
	/N		/D
/E		/P	

9.

/C

**R HS H.F.
REACH**

10.

/S

/

/



SMD- 1
SMD 1 . .

/N

/D

/E

/P

11. /P

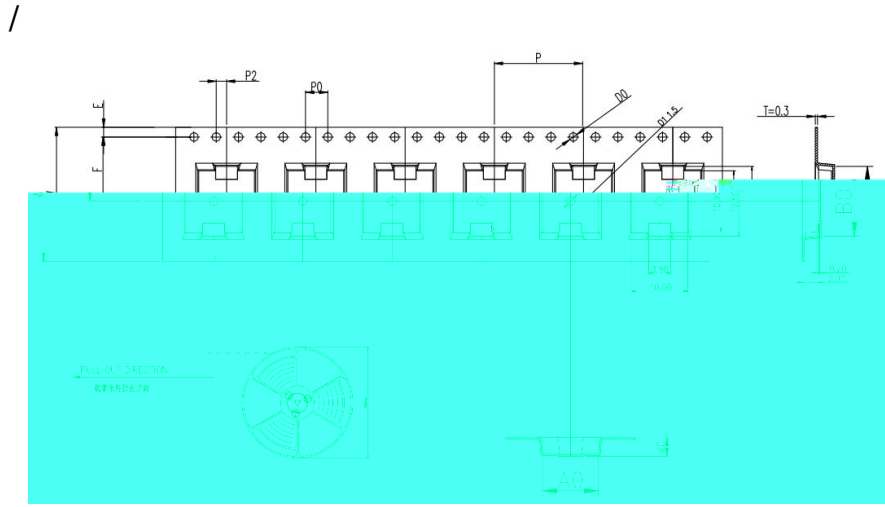

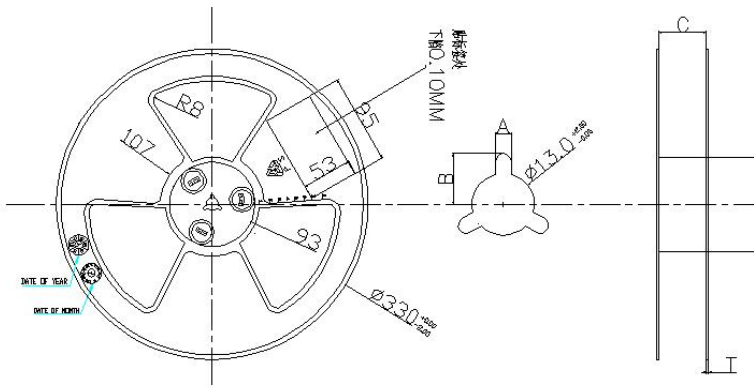

ITEM	W	A0	B0	K1	K0	P	F	E	D0	D1	P0	P2	T
DIM	24.0	$+0.30$ -0.30	$+0.10$ -0.10	$+0.10$ -0.10	3.45	$+0.10$ -0.10	$+0.10$ -0.10	1.75	$+0.10$ -0.10	$+0.10$ -0.10	$+0.10$ -0.10	$+0.10$ -0.10	$+0.05$ -0.05

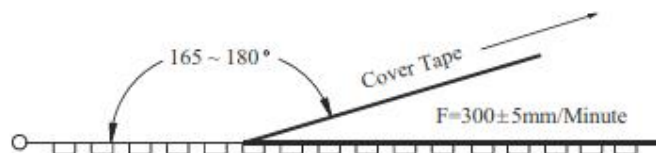

SPEC	A±0.3	B±0.5	C $+0.5$ -0.0	D±0.5	T±0.2
24	2.3	10.75	24.4	Ø97	2.2

Item	Data	Remark
Cover tape adhesion	10 ~ 100g	Carrier tape and cover tape open angle 165 ~ 180° F=300± 5mm/minute



 TRX 专注电容器廿年	SMD- 1		
	SMD 1 . .		
	/N		/D
		/P	

/ -

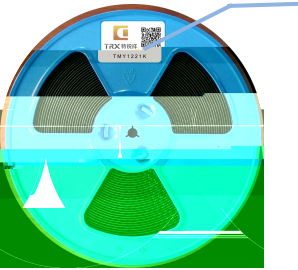



TRX 特锐祥
TGY1102K



TRX Des: TRX-SMD Y. CAP
P/N: /
QM Mfr: TGY1102K
D/C: 2021.11.15
LOT. NO: BSC2108015002
QTY: 1000 PCS
SPEC: SMD-Y1Y5P102K/AC400V

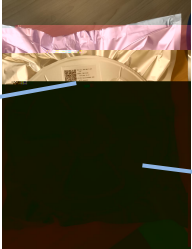

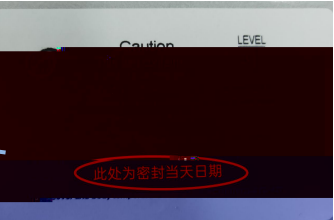

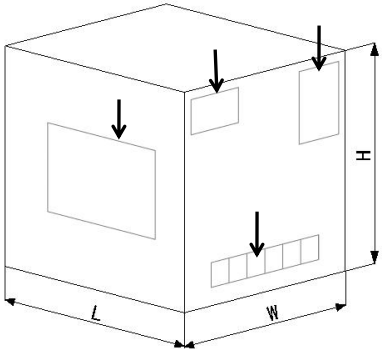

Caution LEVEL
此处为密封当天日期

/O -









TRX Des: TRX-SMD Y. CAP
P/N: /
QM Mfr: TGY1102K
D/C: 2021.11.15
LOT. NO: BSC2108015002
QTY: 1000 PCS
SPEC: SMD-Y1Y5P102K/AC400V

/
/
/

/P :









/
/

" "

R

