

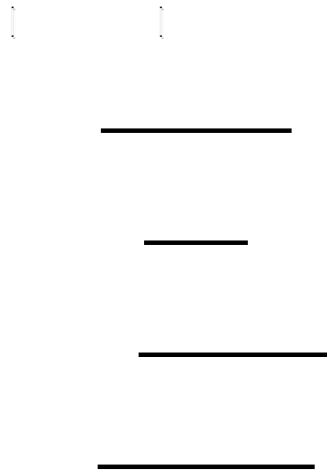

规格承认书





TRX 特锐祥
专注电容器廿年

TRX 电容器一级代理商

深圳市弗瑞鑫电子有限公司

Add : 深圳市宝安区西乡大道302号华丰金源商务大厦B座3楼

Tel : 0755-29563634

Emial : sales@frxelec.com

 TRX 专注电容器廿年	SMD Y2 a.c. ceramic capacitors			
	/Number	- -0 2	/Date	2020-02-10
	/Edition	0	/Page	2 2

/E.C.LIST

	- 2.				
			0		2020-02-10
0	2020-02-10				
			/		

 TRX 专注电容器廿年	SMD Y2 a.c. ceramic capacitors			
	/Number	- 0 2	/Date	2020-02-10
	/Edition	0	/Page	2

/

		
1	/	2 1	- 2 1 / 00	0
2	/	2102	- 2 102 / 00	0
	/	2222	- 2 222 / 00	0
	/	2 2	- 2 2 / 00	0
	/	2 2	- 2 2 / 00	0
10				
11				
12				

2/ attached sheet II

TRX SMD-Y1.CAP

Capacitance Range and T.C Differentiation (Unit:pF)

1

1

T.C	0	1000	2200	00	00
2 ()					
2 ()					
2 ()					
	00 .				
	- 0 12				
	0/ 12 / 21				

1000

100

..

1000 . ,

..

100 .

 TRX 专注电容器廿年	SMD Y2 a.c. ceramic capacitors			
	/Number	- 0 2	/Date	2020-02-10
	/Edition	0	/Page	2

/

1. -----
2. -----
- . -----
- . -----
- . -----
- . -----
- . -----
- . -----
- . -----
- . -----
- . -----
- . -----
10. -----
11. -----
12. -----

 TRX 专注电容器廿年	SMD Y2 a.c. ceramic capacitors			
	/Number	- 0 2	/Date	2020-02-10
	/Edition	0	/Page	2

1. /Product Name

T **G** **Y2** **102** **K** **B**
 ① ② ③ ④ ⑤

.		
①		
②		
③	2	
④	102	(102 10 10 ² 1000)
⑤		/ (10%) / (20%)
		/ () - 0 + 10% () - 0 + 22%/- % () - 0 + 22%/- 2%

!

2. /Product marking

	TL B-102K
--	------------------

 TRX 专注电容器廿年	SMD Y2 a.c. ceramic capacitors			
	/Number	- 0 2	/Date	2020-02-10
	/Edition	0	/Page	2

/Explanation	
	/ /
	- 2 - 2
	() / () / ()
102	(0- 00 1- 2)
	/ (10%) / (20%)
1 0	1 1
2 00	2 2
0 12	

3. /Date code

		2020		1	01	1	01	1	1
		2021		2	02	2	02	1	1
2010		2022			0		0	1	1
2011		202			0		0	1	1
2012		202			0		0	20	20
201		202			0		0	21	21
201		202			0		0	22	22
201		202			0		0	2	2
201		202			0		0	2	2
201		202		10	10	10	10	2	2
201				11	11	11	11	2	2
201				12	12	12	12	2	2
						1	1	2	2
						1	1	2	2
						1	1	0	0
								1	1

3. /Certificates

certificates			
/	/ 0 -1	1 1	00 (. . .)
	/ .1 -201	200012 0 0	00 (. . .)
	0 -1 201 / 1 201	-0 1	00 (. . .)
	0 -1	0 0 -2100	2 0 (. . .)

5. /Product structure

.1 /

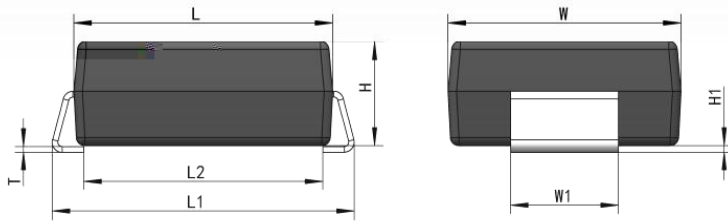

()			
	.0 0.		. 0.
1	.0 0.	2	. 0.
	2. 0.1	1	2. 0.0
1	0.1 0.0		0.1 0.02

.2 /

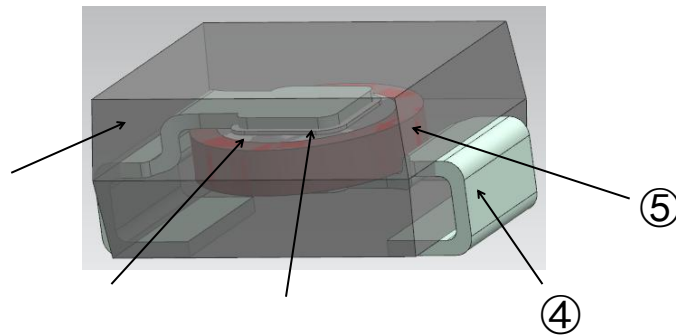

.		
①		(-0) (-0)
②		
③		- - - -
④		
⑤		

01 02 03 04 05 06 07 08 09 10 11 12

专	/Numb	0	/Date	2020-0
				25PC

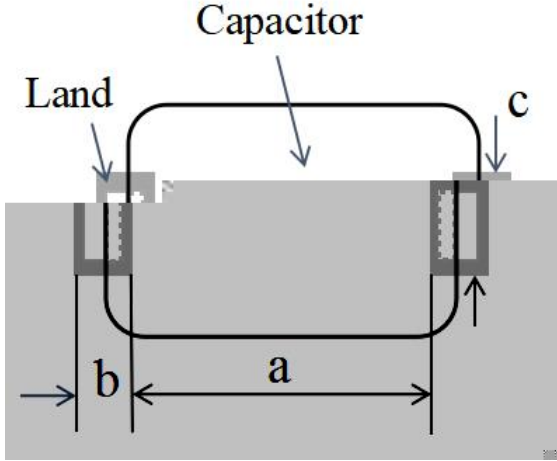

 TRX 专注电容器廿年	SMD Y2 a.c. ceramic capacitors			
	/Number	- -0 2	/Date	2020-02-10
	/Edition	0	/Page	2

.2 /

2 0 °
 2 0°C
 0 °
 0 °
 200 °
 200 °
 1 0 °
 1 0 °

. /

/

/ ,

00
 - 00
 0
 0

7. / Performance and test methods

1			
2		.1 .1	



TRX
专注电容器廿年

SMD Y2 a.c. ceramic capacitors

/Number

- -0 2

/Date

2020-02-10

/Edition

0

/Page

10 2

					$\frac{2.00}{0.0}$ $\frac{0}{0}$												
		10%			$\frac{2}{0\%}$ $\frac{1.0}{0.2}$ $\frac{1}{0.2}$												
		2. %			$\frac{2}{0\%}$ $\frac{1.0}{0.2}$ $\frac{1}{0.2}$												
		10%			<table border="1"> <tr> <td></td> <td>1</td> <td>2</td> <td></td> <td></td> <td></td> </tr> <tr> <td>()</td> <td>+20</td> <td>-2</td> <td>+20</td> <td>+</td> <td>+20</td> </tr> </table> $\Delta \frac{-0}{0}$ $2,$		1	2				()	+20	-2	+20	+	+20
	1	2															
()	+20	-2	+20	+	+20												
		000			$\frac{000}{1}$												
		000			$\frac{000}{1}$												

 TRX 专注电容器廿年	SMD Y2 a.c. ceramic capacitors			
	/Number	- -0 2	/Date	2020-02-10
	/Edition	0	/Page	11 2



 TRX 专注电容器廿年	SMD Y2 a.c. ceramic capacitors			
	/Number	- -0 2	/Date	2020-02-10
	/Edition	0	/Page	12 2



10 10

/ 0.

11

10%

1 %

1 %

2

2. %

2

, ,

/ 0 2

/ %

$\Delta (-0)/0$

/ 21

$\Delta 10\%$

(00)

$\Delta 1\%$

12

$\Delta 1\%$

(00)

()

2

2 2

2 2 2

000

/ 12

/ 1000_{-0}^{+2}

10 1.

1000

$\Delta (-0)/0$

0.1

$\Delta 10\%$

10 1.

$\Delta 1\%$

1000 . . . 0.1 .

1

$\Delta 1\%$

%

%,

2

2 2

000

2

2 2

1			.0
	2		10
	2		2
1			0
	0	0	0

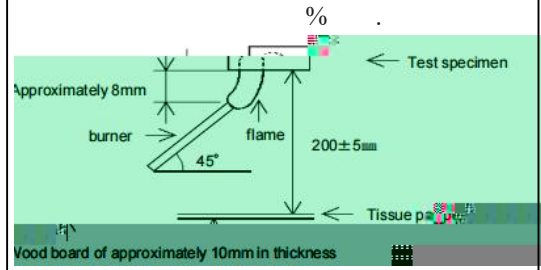

Approximately 8mm

burner

45°

flame

200±5mm

Test specimen

Tissue paper

Wood board of approximately 10mm in thickness

1									
1									

8. /Capacitor temperature characteristic

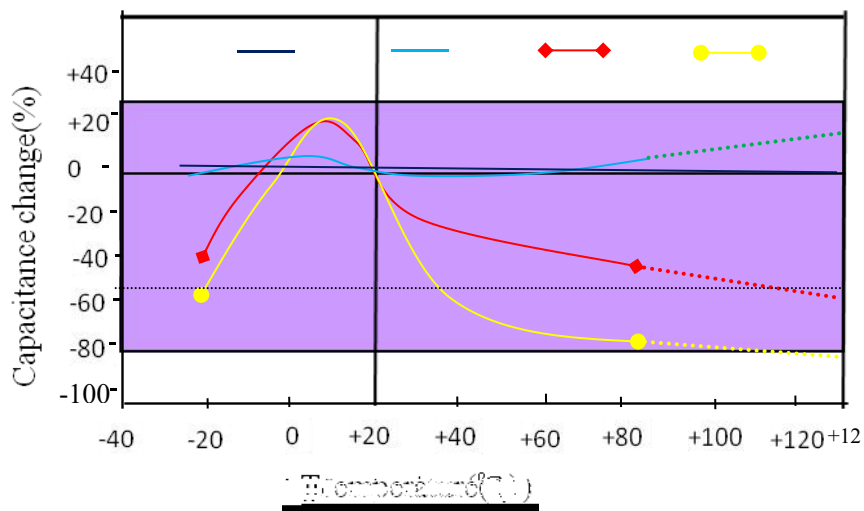

 TRX 专注电容器廿年	SMD Y2 a.c. ceramic capacitors			
	/Number	- -0 2	/Date	2020-02-10
	/Edition	0	/Page	1 2

9. /Content of toxic and harmful substances control requirements

2.0 2011/ /

1 0 /200



	()
/	100
/	1000
/	1000
/	1000
/	1000
/	1000
+ + + / + + + + ()	100
/	00
/	00
+ / +	1 00
()	

10. /Storage conditions

(1).

(2).

(3).

(4).

(0 1)

(0 1)

11. /Product packaging

11.1 /

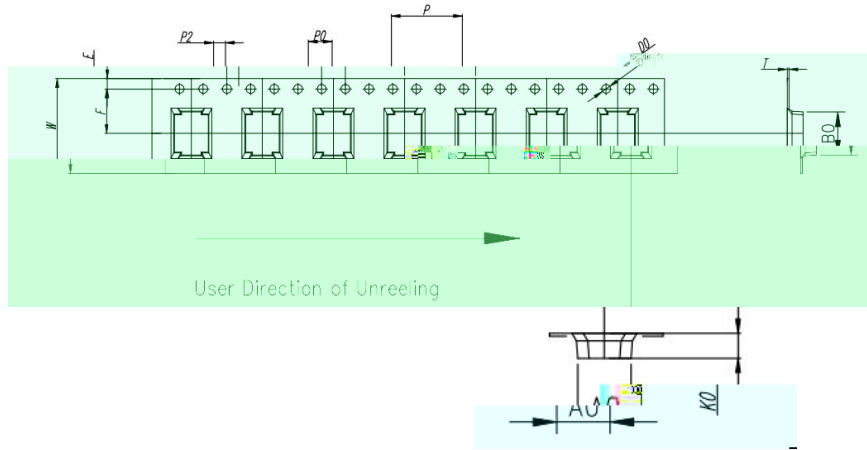

未标注斜角为: 5°.

ITEM	W	A0	B0	K1	K0	P	F	E	D0	D1	P0	P2	T												
DIM	16.0	$+0.30$ -0.30	5.70	$+0.10$ -0.10	7.30	---	$+0.10$ -0.10	2.70	$+0.10$ -0.10	12.0	$+0.10$ -0.10	7.50	$+0.10$ -0.10	1.75	$+0.10$ -0.10	0.15	$+0.10$ -0.10	0.00	$+0.10$ -0.10	4.0	$+0.10$ -0.10	2.0	$+0.10$ -0.10	0.30	$+0.05$ -0.05
ALTERNATE																									

11.2 /

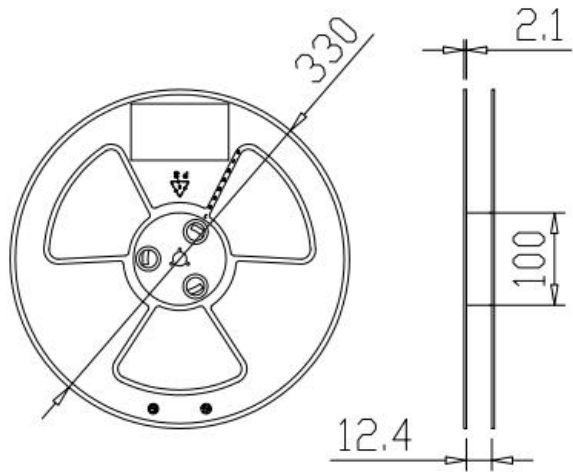

000	1
-----	---



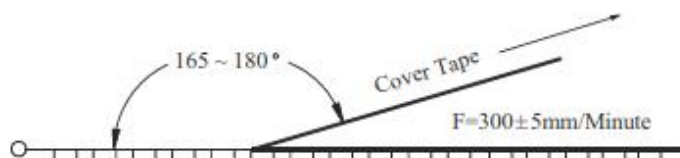

11. /



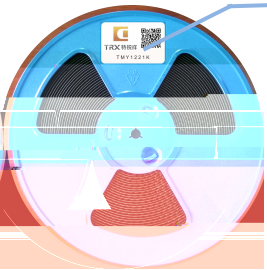

Item	Data	Remark
Cover tape adhesion	10 ~ 100g	Carrier tape and cover tape open angle 165 ~ 180° F=300± 5mm/minute

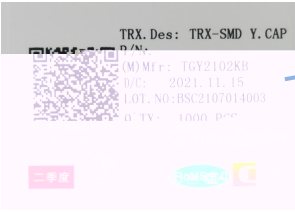

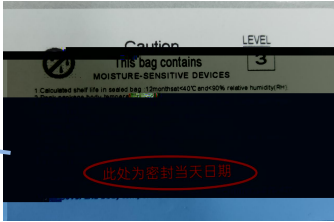

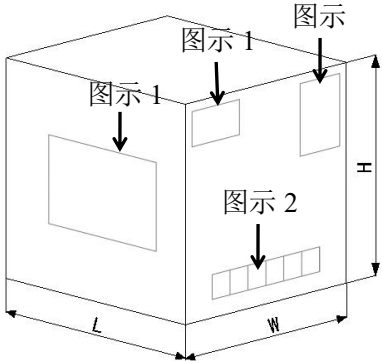

 TRX 专注电容器廿年	SMD Y2 a.c. ceramic capacitors			
	/Number	- 0 2	/Date	2020-02-10
	/Edition	0	/Page	1 2

11. /

/inner-packaging			
 <p>标签/</p>	 <p>料号</p>		
/	1	/	
.0	/		
		 <p>此处为密封当天日期</p>	
/	/	/	

/Outer-packaging			
			
图示 1/	1	图示 2/	2
		图示 /	
()			
		2	1 .0

/Package sketch:			
			
/	1	(/ /)	(/ /)
	/ /	(/ /)	(/ /)
		1100*1100* 0	1100*1100*1 00

1.		2.	&
. 0	/		
Remark 1.		2.	& -
/	. 0		

	SMD Y2 a.c. ceramic capacitors			
	/Number	- -0 2	/Date	2020-02-10
	/Edition	0	/Page	1 2

12. /Application notes

①.

②.

()

③.

④.

⑤.

⑥.